



Heavy Duty Parts Catalog





SilverbackHD Customer Service
1-855-244-SBSB (7272) Toll Free

SilverbackHD Tech Line
1-855-848-TECH (8324) Toll Free

Cross Reference on
SilverbackHD Website

www.silverbackhd.com

SilverbackHD is a registered trademark of SilverbackHD Products, Inc. Aero Gear, Alliance, Automann, Accuride, Allison, Bendix, Bendix ADB22X™, Bosch, Clark, Conti Tech, Dana, Dayton, Dexter, Dodge, Eaton, Ford, Firestone, Fleetpride, Fleetrite, Freightliner, Fruehauf, GM, Goodyear Veyance, Goodyear Stemco, Granning, Hayes, Hendrickson, IHC, Intraax®, Isuzu, Kenworth, Kershaw, KIC, Kenworth, Mack, Meritor, MotorWheel, Navistar, Peterbilt, Pro-Par, Reyco Granning, Ridewell, Road Choice, SAF Holland, Spicer, Standard Forge, Triangle, TRP, TRW, Volvo, Wabco, Watson & Chalin, Workhorse and World America are registered trademarks of their respective companies. Any references in this catalogue to company names or trademarks are solely for identification and cross reference purposes and implies no rights of ownership by SilverbackHD Products.



BRAKE PRODUCTS

Drum Brake	02
Brake Wheel Kits	02
Brake Hardware Kits	08
Brake Drums	11
Camshafts.....	14
Camshaft Repair Kits (CRK Kits)	20
Slack Adjusters.....	25
Chambers	30
Air Chambers	30
Hydraulic Disc Brake	34
Hydraulic Pads	34
Hydraulic Calipers	36
Hydraulic Rotors.....	38
Air Disc Brake	40
Air Disc Pads	40
Air Disc Calipers	44
Air Disc Rotors.....	47
Other	49
Parking Brakes (E-Brakes).....	49

SUSPENSION PRODUCTS

Air Springs	51
Air Springs	51

TOOLTIP

Numerical Parts Listing	71
Numerical Parts Listing.....	71



BRAKE WHEEL KITS



New Steel Shoes

NO CORES !

Ceramic Friction

Runs Cooler
Stops Faster
Lasts Longer

Hardware

Complete Kit
Severe Duty
Long Life

Heavy Duty Brake Wheel Kit Identification Requires 6 Simple Steps

A. Identify shoe width.



Determine the width of the shoe by measuring the shoe width as shown above. This 4707Q+ measures 7.00" in width.

B. Identify drum diameter.

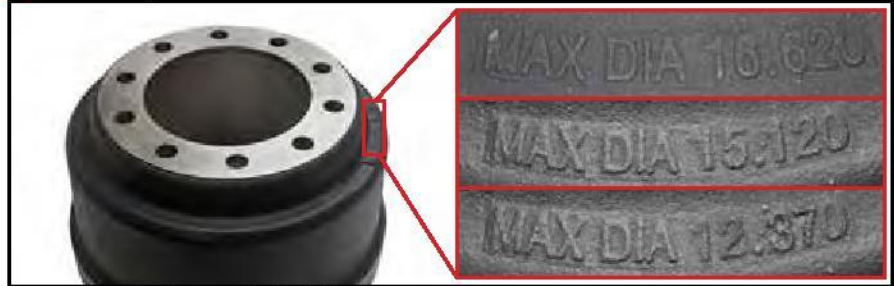

Drum diameter is equal to the Maximum Diameter that is stamped in your drum (minus 0.12").

Drum Casting	Drum Diameter
16.62"	16.50"
15.12"	15.00"
12.37"	12.25"

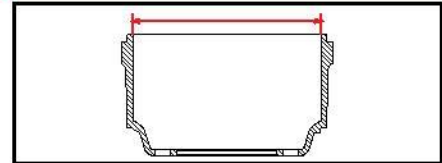

Measure brake surface diameter.

C. Identify shoe style.



Meritor-style shoes have a 1.00" wide claw shaped anchor end. They are also known as "Q" or "Q+" shoes because they can be quickly changed and do not have pin-styled ends.



Eaton-style shoes have a distinctively wider anchor end that measures approximately 1.25" wide.

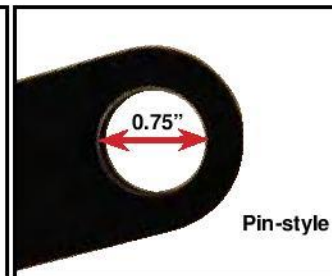

Pin-style shoes use roller pins and/or anchor pins to secure the shoes in place. Unlike the previous styles, this end is closed and is commonly found on 7.50" wide by 12.25" diameter shoes.

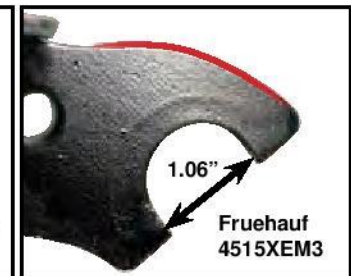

Fruehauf-style shoes have humps on the anchor end.

D. Count number of webs.

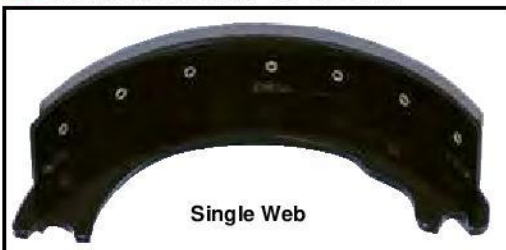

Single Web

Pre-1995 steer shoes used a single web. After 1994, most steer shoes became double web.



Double Web

E. Identify shoe features.

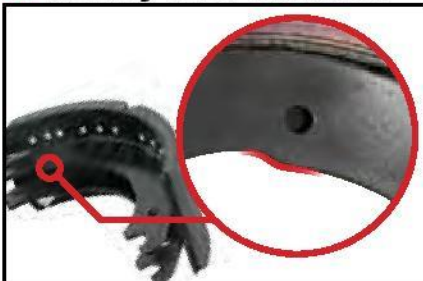

Q-style shoe with hump near pin hole.



Narrowing cam end webs

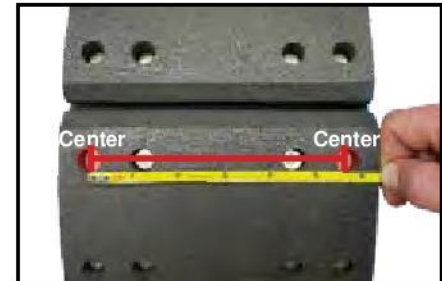

Center to center outside row of rivets.

F. Use chart and pictures to identify brake wheel kits.



A Shoe Width	B Drum Dia.	C Shoe Style	D Web Qty.	E Features	Hardware Kit Part #	SilverbackHD Part #		
						20K	23K	23K High Temp Severe Duty
4.00" Brake Shoes								
4.00"	15.00"	Eaton	1	Center to center of rivets is 2.75". 14 rivets.	HK1308E	WK1308E-20KSB	WK1308E-23KSB	
4.00"	15.00"	Eaton	1	Center to center of rivets is 2.00". 14 rivets.	HK1308E	WK1443E-20KSB	WK1443E-23KSB	
4.00"	15.00"	Eaton	2	16 rivets.	HK4729E	WK4729ES-20KSB	WK4729ES-23KSB	
4.00"	15.00"	Meritor	1	Pre-1995. 14 rivets.	HK1308Q	WK1308Q-20KSB	WK1308Q-23KSB	
4.00"	15.00"	Meritor	2	No hump in web. 16 rivets.	HK4702Q	WK4702Q-20KSB	WK4702Q-23KSB	
5.00" Brake Shoes								
5.00"	15.00"	Meritor	2	No hump in web. Steer axle.	HK4702Q	WK4703Q-20KSB	WK4703Q-23KSB	
5.00"	16.50"	Eaton	2	Steer axle.	HK4719E	WK4719ES2-20KSB	WK4719ES-23KSB	
5.00"	16.50"	Meritor	2	Webs have small hump near hole. 1.05" from table. Drive axle. Center to Center outside row of rivets 3.38".	HK4515Q-34	WK4524Q-20KSB	WK4524Q-23KSB	
5.00"	16.50"	Meritor	2	Webs have small hump near hole. 0.55" from table. Steer axle.	HK1657QM	WK4524QR-20KSB	WK4524QR-23KSB	
5.00"	16.50"	Meritor	2	Center to Center outside row of rivets 3.63". No hump in web.	HK1657QM	WK4720Q-20KSB	WK4720Q-23KSB	
6.00" Brake Shoes								
6.00"	15.00"	Meritor	2	No hump in web.	HK4702Q		WK4704Q-23KSB	
6.00"	16.50"	Eaton	2		HK4719E	WK4725ES2-20KSB	WK4725ES2-23KSB	
6.00"	16.50"	Meritor	2	Webs have small hump near hole. 1.05" from table. Drive axle. Center to Center outside row of rivets 3.38".	HK4515Q-34	WK4514Q-20KSB	WK4514Q-23KSB	
6.00"	16.50"	Meritor	2	Webs have small hump near hole. 0.55" from table. Steer axle.	HK1657QM	WK4514QR-20KSB	WK4514QR-23KSB	
6.00"	16.50"	Meritor	2	Center to Center outside row of rivets 3.63". No hump in web.	HK1657QM	WK4715Q-20KSB	WK4715Q-23KSB	
7.00" Brake Shoes								
7.00"	15.00"	Meritor	2	No hump in web.	HK4702Q		WK4705Q-23KSB	
7.00"	16.50"	Eaton	2	Webs narrow at roller end from 2.00" to 1.00".	HK4311E	WK4311E-20KSB	WK4311E-23KSB	
7.00"	16.50"	Eaton	2	ES2 shoes have no spring attaching tabs on table(4709ES2 replaces 4709ES).	HK4709E-12	WK4709ES2-20KSB	WK4709ES2-23KSB	WK4709ES2-23KSBHTP



A Shoe Width	B Drum Dia.	C Shoe Style	D Web Qty.	E Features	Hardware Kit Part #	SilverbackHD Part #		
						20K	23K	23K High Temp Severe Duty
7.00"	16.50"	Eaton	2	Same as 4709ES2, but requires two small return springs per wheel for steer axle.	HK4719E		WK4709ES2F-23KSB	
7.00"	16.50"	Fruehauf	2	Webs have small hump near hole, plus hump on anchor end of webs.	HK4515F-3	WK4515XEM3-20KSB	WK4515XEM3-23KSB	
7.00"	16.50"	Meritor	2	Webs have small hump near hole. Center to Center outside row of rivets 5.38".	HK4515Q-34	WK4515Q-20KSB	WK4515Q-23KSB	WK4515Q-23KSBHTP
7.00"	16.50"	Meritor	2	Center to Center outside row of rivets 5.63". No hump in web.	HK4515Q-34	WK4707Q-20KSB	WK4707Q-23KSB	WK4707Q-20KSBHTP
7.00"	16.50"	Meritor	2	Same as 4707Q, except steer axle.	HK1657QM		WK4707QR-23KSB	
7.50" Brake Shoes								
7.50"	12.25"	Meritor (Dexter)	2	24 rivets. Closed roller pin hole. Hump at anchor end. Open anchor pin end.	HK1225DX	WK4591DX-20KSB	WK4591DX-23KSB	
7.50"	12.25"	Meritor	2	20 rivets. Closed roller pin hole. No hump at anchor end. Open anchor pin end.	HK1225Q	WK4670Q-20KSB	WK4670Q-23KSB	
7.50"	12.25"	Meritor (Spicer)	2	20 rivets. Open at both roller end and anchor end. 3 holes in each web. Old style had notches in webs for hold down spring. New style 4692Q replaces old style.	HK1225D-150	WK4692Q-20KSB	WK4692Q-23KSB	
7.50"	12.25"	Pin-Style (Standard Forge)	2	24 rivets. Roller and anchor holes closed both ends.	HK1225SF	WK4591SF-20KSB	WK4591SF-23KSB	
8.00" Brake Shoes								
8.00"	16.50"	Meritor	2	No hump in web.	HK4515Q-34	WK4718Q-20KSB	WK4718Q-23KSB	WK4718Q-23KSBHTP
8.62" Brake Shoes								
8.62"	15.00"	Meritor	2	No hump in web.	HK4702Q	WK4710Q-20KSB	WK4710Q-23KSB	WK4710Q-23KSBHTP
8.62"	16.50"	Eaton	2		HK4709E-12	WK4726ES2-20KSB	WK4726ES2-23KSB	WK4726ES2-23KSBHTP
8.62"	16.50"	Meritor	2	Webs have small hump near hole. Center to Center outside row of rivets 7.00".	HK4515Q-34	WK4551Q-20KSB	WK4551Q-23KSB	
8.62"	16.50"	Meritor	2	Center to Center outside row of rivets 6.63". No hump in web.	HK4515Q-34	WK4711Q-20KSB	WK4711Q-23KSB	WK4711Q-23KSBHTP

4.00" Brake Shoes



5.00" Brake Shoes



6.00" Brake Shoes



7.00" Brake Shoes



7.50" Brake Shoes



8.00" Brake Shoes



8.62" Brake Shoes



* Available in 20KSB or 23KSB when ordering

** Available in 20KSB, 23KSB or 23KSBHTP when ordering



BRAKE HARDWARE KITS

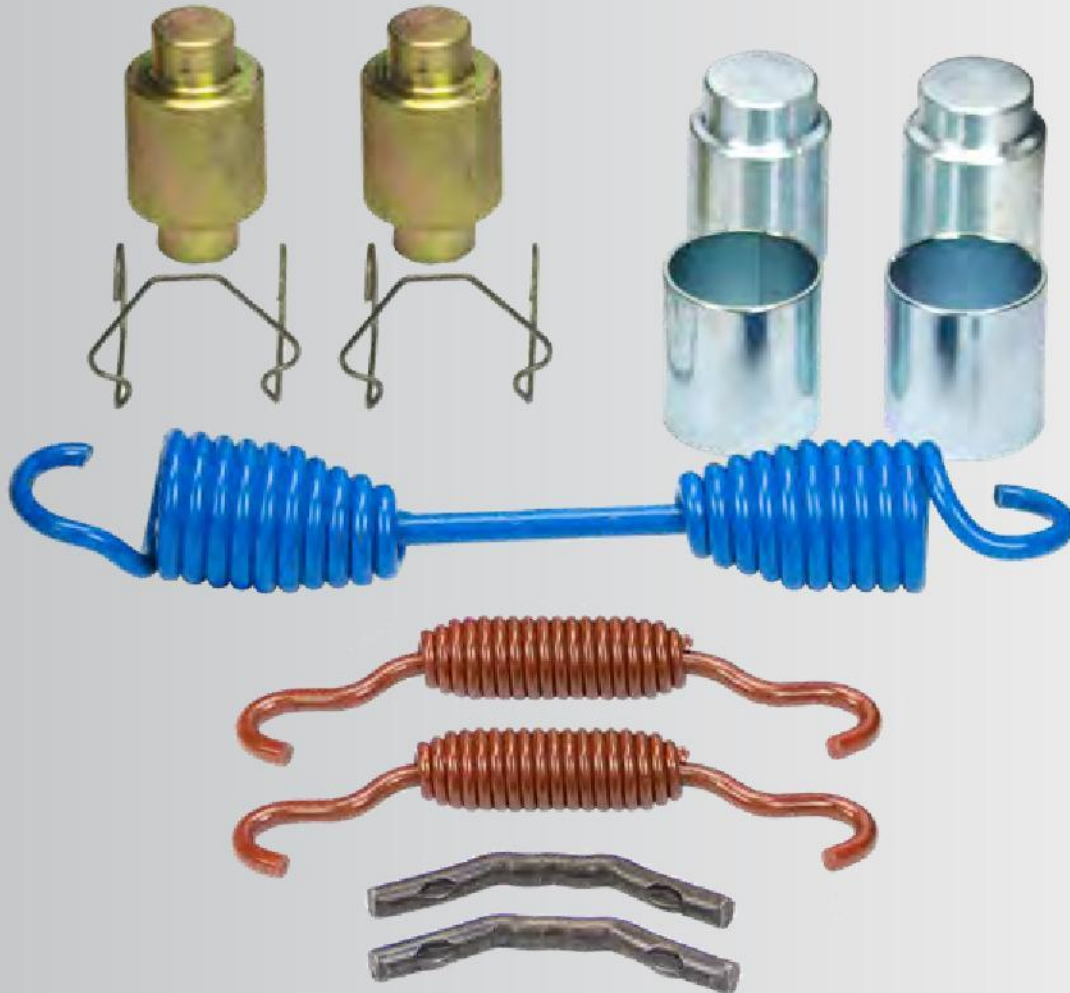

**Powder Coated
Springs**

**Heat-Treated
Components**

**Severe Duty
Long Life**



Heavy Duty Hardware Kit Identification Requires 3 Simple Steps

- A. Find SilverbackHD Brake Wheel Kit in the first column.**
- B. Locate hardware kit in the second column.**
- C. Use pictures to identify hardware kits.**

A	B	
SilverbackHD Brake Wheel Kit Part #	Brake Hardware Kit	Application
WK1308E	HK1308E	4.00" x 15.00" Single Web Eaton Steer
WK1308Q	HK1308Q	4.00" x 15.00" Single Web Meritor Q Steer
WK1443E	HK1308E	4.00" x 15.00" Single Web Eaton ES Steer
WK4311E	HK4311E	7.00" x 16.50" Eaton Rear and Trailer
WK4514Q	HK4515Q-34	6.00" x 16.50" Q Standard Mount Rear
WK4514QR	HK1657QM	6.00" x 16.50" Q High Mount Steer
WK4515Q	HK4515Q-34	7.00" x 16.50" Q Rear and Trailer
WK4515XEM3	HK4515F-3	7.00" x 16.50" XEM3 Fruehauf Trailer
WK4524Q	HK4515Q-34	5.00" x 16.50" Q Standard Mount Rear
WK4524QR	HK1657QM	5.00" x 16.50" Q High Mount Steer
WK4551Q	HK4515Q-34	8.62" x 16.50" Q Trailer
WK4591DX	HK1225DX	7.50" x 12.25" Dexter Lowboy
WK4591SF	HK1225SF	7.50" x 12.25" Standard Forge Lowboy
WK4670Q	HK1225Q	7.50" x 12.25" Meritor Lowboy
WK4692Q	HK1225D-150	7.50" x 12.25" Spicer Lowboy
WK4702Q	HK4702Q	4.00" x 15.00" Double Web Q+ Steer
WK4703Q	HK4702Q	5.00" x 15.00" Q+ Steer
WK4704Q	HK4702Q	6.00" x 15.00" Q+ Steer or Rear
WK4705Q	HK4702Q	7.00" x 15.00" Q+ Steer or Rear
WK4707Q	HK4515Q-34	7.00" x 16.50" Q+ Rear and Trailer
WK4707QR	HK1657QM	7.00" x 16.50" Q+ Hi Mount Steer
WK4709ES2	HK4709E-12	7.00" x 16.50" Eaton ES2 Rear and Trailer
WK4709ES2F	HK4719E	7.00" x 16.50" Eaton ES2 Steer
WK4710Q	HK4702Q	8.62" x 15.00" Q+ Rear
WK4711Q	HK4515Q-34	8.62" x 16.50" Q+ Rear and Trailer
WK4715Q	HK1657QM	6.00" x 16.50" Q+ Steer or Rear
WK4718Q	HK4515Q-34	8.00" x 16.50" Q+ Rear
WK4719ES2	HK4719E	5.00" x 16.50" Eaton ES Steer
WK4720Q	HK1657QM	5.00" x 16.50" Q+ Steer
WK4725ES2	HK4719E	6.00" x 16.50" Eaton ES Steer or Rear
WK4726ES2	HK4709E-12	8.62" x 16.50" Eaton ES Rear and Trailer
WK4729ES	HK4729E	4.00" x 15.00" Double Web Eaton ES Steer



HK1225D-150



HK1225DX



HK1225SF



HK1225Q

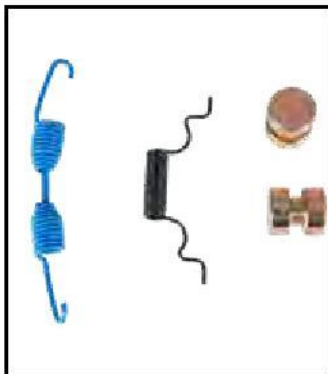

HK1308E



HK1308Q

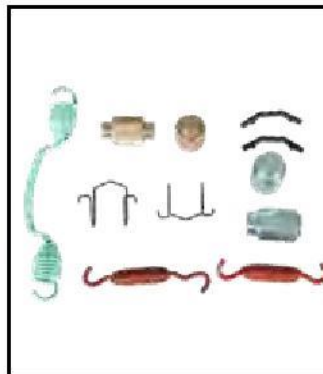

HK1657QM



HK4311E



HK4515F-3



HK4515Q-34



HK4702Q



HK4709E-12



HK4719E



HK4729E



BRAKE DRUMS



**High Carbon
Metallurgy**

**35,000 psi Tensile
Strength**

**Computer Aided
Balancing**

**Runs Cooler
Lasts Longer**

Safe and Durable

Smooth Ride



Heavy Duty Brake Drum Identification Requires 8 Simple Steps

A. Brake Surface Diameter.

B. Pilot Diameter.

C. Bolt Circle Diameter.

D. Number of Bolt Holes.

E. Overall Depth.

F. Brake Surface Width.

G. Bolt Hole Size.

H. Use chart to finalize selection.

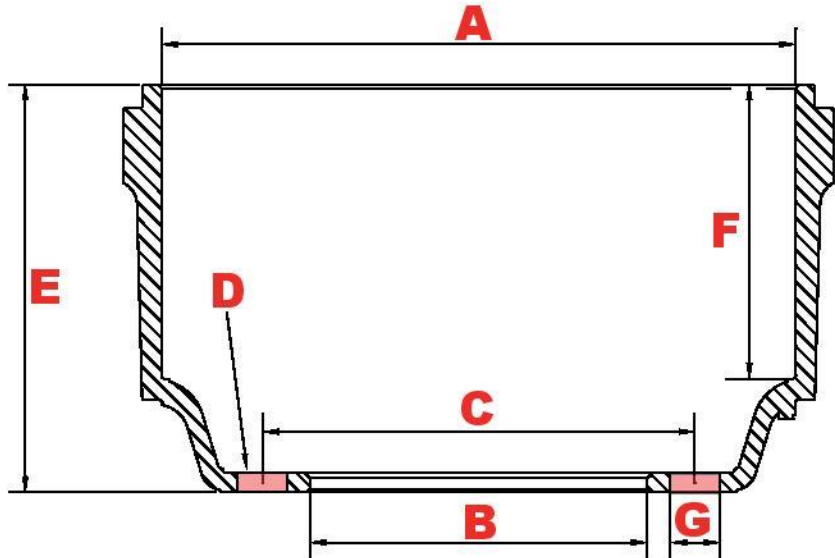

A	B	C	D	E	F	G	SilverbackHD Part #
Brake Surface Dia.	Pilot Dia.	Bolt Circle Dia.	Num. of Bolt Holes	Overall Depth	Brake Surface Width	Bolt Hole Size	
12.25" Diameter Drums							
12.25"	7.00"	8.25"	6	9.10"	8.00"	0.65"	34BD67BB
12.25"	7.12"	8.75"	10	10.47"	8.24"	0.81"	35BD57B
12.25"	8.50"	10.00"	6	8.88"	8.00"	0.65"	31BD74B
12.25"	9.00"	10.82"	8	11.22"	10.00"	1.00"	38BD87B
15.00" Diameter Drums							
15.00"	8.78"	11.25"	10	8.79"	4.78"	1.25"	37BD21AB
15.00"	8.78"	11.25"	10	9.18"	4.66"	1.25"	38BD00B
15.00"	8.78"	11.25"	10	9.33"	5.42"	1.25"	37BD74B
15.00"	8.78"	11.25"	10	10.28"	7.14"	1.00"	37BD53B
15.00"	8.78"	11.25"	10	11.90"	9.30"	1.00"	37BD44B
15.00"	9.00"	11.25"	10	8.91"	4.40"	1.25"	31BD58B
15.00"	9.25"	11.25"	5/6	5.85"	4.61"	0.78"	37BD60BB
16.50" Diameter Drums							
16.50"	8.53"	11.25"	10	10.38"	7.70"	0.81"	36BD99B
16.50"	8.53"	11.25"	10	10.59"	7.63"	0.81"	31BD66B
16.50"	8.78"	11.25"	10	9.04"	5.38"	1.25"	37BD10B
16.50"	8.78"	11.25"	10	9.37"	5.43"	1.25"	37BD58B

A	B	C	D	E	F	G	SilverbackHD Part #
Brake Surface Dia.	Pilot Dia.	Bolt Circle Dia.	Num. of Bolt Holes	Overall Depth	Brake Surface Width	Bolt Hole Size	
16.50"	8.78"	11.25"	10	9.80"	6.52"	1.25"	36BD87B
16.50"	8.78"	11.25"	10	10.12"	7.50"	1.00"	37BD96B
16.50"	8.78"	11.25"	10	10.30"	7.40"	1.00"	34BD02B
16.50"	8.78"	11.25"	10	10.54"	7.60"	1.00"	35BD76B
16.50"	8.78"	11.25"	10	10.56"	7.60"	1.00"	36BD00AB
16.50"	8.78"	11.25"	10	10.82"	7.70"	1.00"	38BD89B
16.50"	8.78"	11.25"	10	11.06"	8.60"	1.00"	37BD82B
16.50"	8.78"	11.25"	10	11.18"	7.44"	1.00"	37BD57B
16.50"	8.78"	11.25"	10	11.39"	9.08"	1.00"	38BD07AB
16.50"	9.00"	10.82"	8	10.59"	7.75"	1.00"	31BD41BB
16.50"	9.00"	11.25"	10	10.59"	7.75"	0.81"	31BD41B
16.50"	9.44"	11.00"	5/6	8.41"	7.63"	0.65"/0.78"	29BD83CB
16.50"	9.44"	11.25"	10	9.50"	7.56"	0.85"	27BD05B
16.50"	9.44"	11.25"	10	10.74"	7.52"	0.84"	31BD20B
16.50"	9.50"	11.25"	10	8.74"	7.50"	0.81"	30BD18AB
16.50"	9.50"	11.25"	5/6	8.75"	7.50"	0.65"/0.81"	25BD46CB
16.50"	10.50"	12.75"	5/6	8.74"	7.58"	0.78"	29BD97DB
16.50"	11.00"	12.75"	6	7.93"	7.31"	0.65"	86BD56B
16.50"	11.25"	12.75"	6	7.43"	6.40"	0.78"	30BD22BB
16.50"	11.25"	12.75"	5/6	8.46"	7.41"	0.78"	32BD95AB





CAMSHAFTS



Machined Heads

**Stone Ground
Journals**

**Heat-Treated
Head and Spline**

Heavy Duty Camshaft Identification Requires 8 Simple Steps

- A. Measure camshaft length. Measure from under the camshaft head to the beginning of the lock ring groove.**

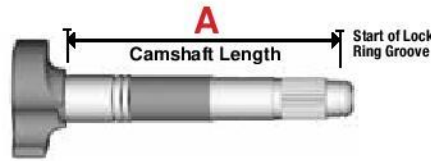

- B. Determine camshaft head type.**

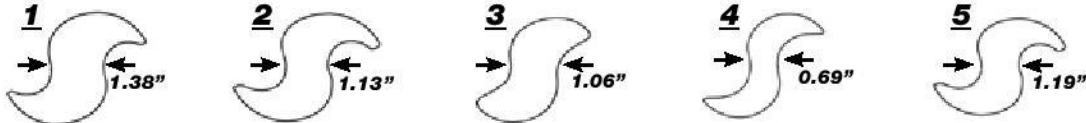

- C. Determine if camshaft is left or right. Put the camshaft on a table with the shaft pointing away from you and the head closest to you. If the tip of the cam that points up is on the right, the cam is right hand. If the tip of the cam that points up is on the left, the cam is left hand.**

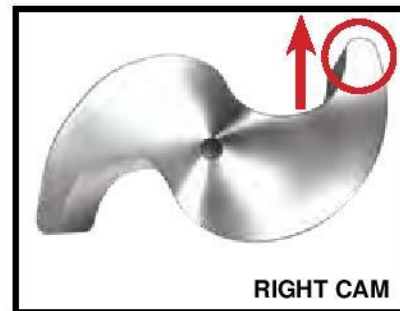
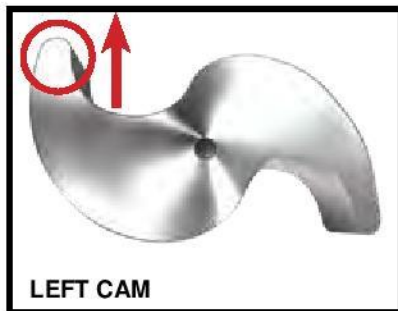

- D. Determine spline size and number of splines.**



- E. Determine bearing journal diameter.**



- F. Measure length to first groove if needed.**



- G. Measure length to second groove if needed.**

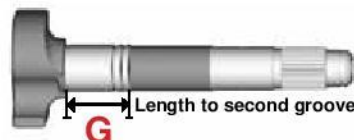

- H. Use chart to select camshaft and cam repair kit part numbers.**

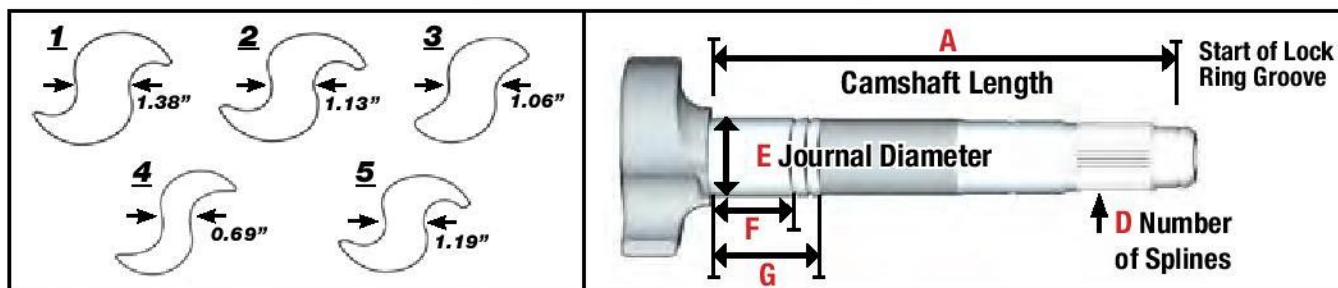

A	B	C	D	E	F	G	Camshaft Part #	CRK Kit	Manufacturer and Brake Size
Camshaft Length	Head Type	Left or Right	Spline Size and Num. of Splines	Journal Dia.	Length to 1st Groove	Length to 2nd Groove			
7.41"	1	Left	1.50"-10	1.50"	2.22"	N/A	CS4892L	CRK2089B CRK2088AB CRK2287B	Multiple Apps.
7.41"	1	Right	1.50"-10	1.50"	2.22"	N/A	CS4893R	CRK2089B CRK2088AB CRK2287B	Multiple Apps.
8.56"	5	Left	1.50"-28	1.50"	N/A	N/A	CS9649L	CRK3993BB CRK9080B	Meritor 16.50" Q+
8.56"	5	Right	1.50"-28	1.50"	N/A	N/A	CS9650R	CRK3993BB CRK9080B	Meritor 16.50" Q+
9.70"	5	Left	1.50"-28	1.50"	N/A	N/A	CS11529L	CRK3993BB CRK9080B	Meritor 16.50" Q+
9.70"	5	Right	1.50"-28	1.50"	N/A	N/A	CS11528R	CRK3993BB CRK9080B	Meritor 16.50" Q+
10.41"	5	Left	1.50"-28	1.50"	N/A	N/A	CS9655L	CRK3993BB CRK9080B	Meritor 16.50" Q+
10.41"	5	Right	1.50"-28	1.50"	N/A	N/A	CS9656R	CRK3993BB CRK9080B	Meritor 16.50" Q+
10.94"	5	Left	1.50"-28	1.50"	N/A	N/A	CS9657L	CRK3993BB CRK9080B	Meritor 16.50" Q+
10.94"	5	Right	1.50"-28	1.50"	N/A	N/A	CS9658R	CRK3993BB CRK9080B	Meritor 16.50" Q+
11.03"	2	Left	1.50"-10	1.50"	2.31"	8.69"	CS11864L	CRK11897B	Hendrickson 16.50"
11.03"	2	Right	1.50"-10	1.50"	2.31"	8.69"	CS11865R	CRK11897B	Hendrickson 16.50"
11.03"	2	Left	1.50"-28	1.50"	2.31"	8.69"	CS11866L	CRK11897B	Hendrickson 16.50"
11.03"	2	Right	1.50"-28	1.50"	2.31"	8.69"	CS11867R	CRK11897B	Hendrickson 16.50"
11.13"	5	Left	1.50"-28	1.50"	N/A	N/A	CS9659L	CRK3993BB CRK9080B	Meritor 16.50" Q+
11.13"	5	Right	1.50"-28	1.50"	N/A	N/A	CS9660R	CRK3993BB CRK9080B	Meritor 16.50" Q+
11.25"	1	Left	1.50"-28	1.50"	N/A	N/A	CS5003L	CRK3993BB	
11.25"	1	Right	1.50"-28	1.50"	N/A	N/A	CS5004R	CRK3993BB	
11.50"	1	Left	1.50"-10	1.50"	N/A	N/A	CS1776L	CRK2125B	Eaton 16.50"
11.50"	1	Right	1.50"-10	1.50"	N/A	N/A	CS1775R	CRK2125B	Eaton 16.50"
11.50"	2	Left	1.50"-10	1.50"	N/A	N/A	CS5492L	CRK10897B	Eaton 15.00" Reduced 16.50" ES
11.50"	2	Right	1.50"-10	1.50"	N/A	N/A	CS5493R	CRK10897B	Eaton 15.00" Reduced 16.50" ES
11.52"	5	Left	1.50"-10	1.50"	N/A	N/A	CS1148CL	CRK3993BB CRK9080B	Meritor 16.50" Q+
11.52"	5	Right	1.50"-10	1.50"	N/A	N/A	CS1147CR	CRK3993BB CRK9080B	Meritor 16.50" Q+
11.56"	5	Left	1.50"-28	1.50"	N/A	N/A	CS9661L	CRK3993BB CRK9080B	Meritor 16.50" Q+
11.56"	5	Right	1.50"-28	1.50"	N/A	N/A	CS9662R	CRK3993BB CRK9080B	Meritor 16.50" Q+

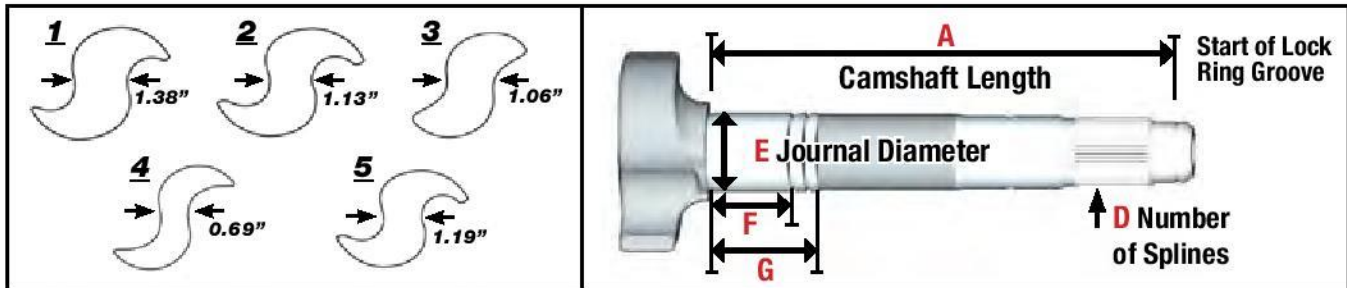

A	B	C	D	E	F	G	Camshaft Part #	CRK Kit	Manufacturer and Brake Size
Camshaft Length	Head Type	Left or Right	Spline Size and Num. of Splines	Journal Dia.	Length to 1st Groove	Length to 2nd Groove			
11.69"	5	Left	1.50"-28	1.50"	N/A	N/A	CS9663L	CRK3993BB CRK9080B	Meritor 16.50" Q+
11.69"	5	Right	1.50"-28	1.50"	N/A	N/A	CS9664R	CRK3993BB CRK9080B	Meritor 16.50" Q+
11.94"	5	Left	1.50"-28	1.50"	N/A	N/A	CS9665L	CRK3993BB CRK9080B	Meritor 16.50" Q+
11.94"	5	Right	1.50"-28	1.50"	N/A	N/A	CS9666R	CRK3993BB CRK9080B	Meritor 16.50" Q+
12.94"	5	Left	1.50"-28	1.50"	N/A	N/A	CS9669L	CRK3993BB CRK9080B	Meritor 16.50" Q+
12.94"	5	Right	1.50"-28	1.50"	N/A	N/A	CS9670R	CRK3993BB CRK9080B	Meritor 16.50" Q+
13.22"	5	Left	1.50"-28	1.50"	N/A	N/A	CS9671L	CRK3993BB CRK9080B	Meritor 16.50" Q+
13.22"	5	Right	1.50"-28	1.50"	N/A	N/A	CS9672R	CRK3993BB CRK9080B	Meritor 16.50" Q+
13.44"	5	Left	1.50"-28	1.50"	N/A	N/A	CS9673AL	CRK3993BB	
13.44"	5	Right	1.50"-28	1.50"	N/A	N/A	CS9674AR	CRK3993BB	
14.09"	5	Left	1.50"-28	1.50"	N/A	N/A	CS9675L	CRK3993BB	Meritor 16.50" Q+
14.09"	5	Right	1.50"-28	1.50"	N/A	N/A	CS9676R	CRK3993BB	Meritor 16.50" Q+
14.59"	5	Left	1.50"-28	1.50"	N/A	N/A	CS9677L	CRK3993BB	Meritor 16.50" Q+
14.59"	5	Right	1.50"-28	1.50"	N/A	N/A	CS9678R	CRK3993BB	Meritor 16.50" Q+
15.18"	5	Left	1.50"-28	1.50"	N/A	N/A	CS9681L	CRK3993BB	Meritor 16.50" Q+
15.18"	5	Right	1.50"-28	1.50"	N/A	N/A	CS9682R	CRK3993BB	Meritor 16.50" Q+
15.72"	5	Left	1.50"-28	1.50"	N/A	N/A	CS9683L	CRK3993BB	Meritor 16.50" Q+
15.72"	5	Right	1.50"-28	1.50"	N/A	N/A	CS9684R	CRK3993BB	Meritor 16.50" Q+
16.13"	1	Left	1.62"-37	1.62"	2.16"	N/A	CS1563L	CRK2090B CRK2122B	Fruehauf 16.50"
16.13"	1	Right	1.62"-37	1.62"	2.16"	N/A	CS1564R	CRK2090B CRK2122B	Fruehauf 16.50"
17.31"	5	Left	1.50"-28	1.62"	1.70"	1.97"	CS5506L	CRK9078B CRK9079B CRK3520AB	
17.31"	5	Right	1.50"-28	1.62"	1.70"	1.97"	CS5507R	CRK9078B CRK9079B CRK3520AB	
17.44"	2	Left	1.50"-28	1.62"	2.25"	N/A	CS9731L	CRK11910B CRK9790AB	Spicer 16.50" XL
17.44"	2	Right	1.50"-28	1.62"	2.25"	N/A	CS9732R	CRK11910B CRK9790AB	Spicer 16.50" XL
20.38"	1	Left	1.50"-28	1.50"	1.63"	2.22"	CS3854L	CRK2287B	Spicer 16.50"
20.38"	1	Right	1.50"-28	1.50"	1.63"	2.22"	CS3855R	CRK2287B	Spicer 16.50"
20.41"	5	Left	1.50"-28	1.62"	1.70"	1.97"	CS5508L	CRK9078B CRK9079B	Meritor 16.50" Q+

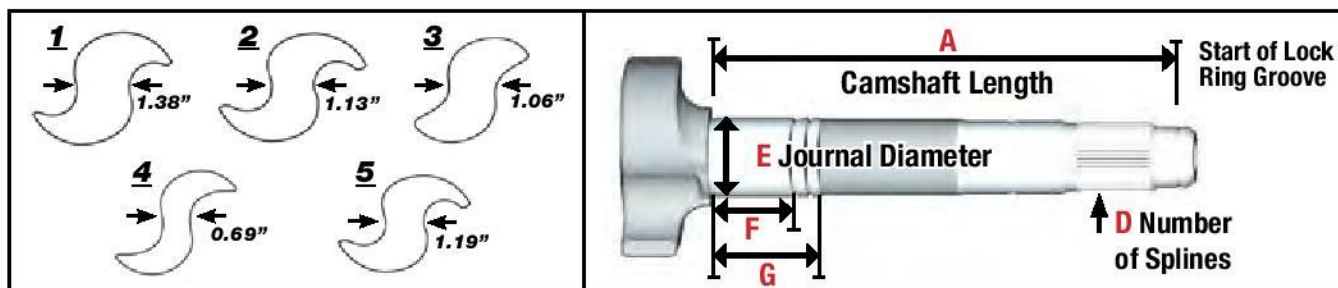

A	B	C	D	E	F	G	Camshaft Part #	CRK Kit	Manufacturer and Brake Size
Camshaft Length	Head Type	Left or Right	Spline Size and Num. of Splines	Journal Dia.	Length to 1st Groove	Length to 2nd Groove			
20.41"	5	Right	1.50"-28	1.62"	1.70"	1.97"	GS5509R	CRK9078B CRK9079B	Meritor 16.50" Q+
20.44"	5	Left	1.50"-10	1.50"	1.63"	2.19"	GS1425AL	CRK2089B CRK2088AB CRK2287B	Meritor 16.50" Q+
20.44"	5	Right	1.50"-10	1.50"	1.63"	2.19"	CS1424AR	CRK2089B CRK2088AB CRK2287B	Meritor 16.50" Q+
20.44"	2	Left	1.50"-28	1.50"	1.63"	2.22"	CS5524L	CRK2287B	Spicer 16.50" XL
20.44"	2	Right	1.50"-28	1.50"	1.63"	2.22"	GS5525R	CRK2287B	Spicer 16.50" XL
20.44"	2	Left	1.50"-28	1.62"	2.25"	N/A	GS9733L	CRK11910B CRK9790AB	Spicer 16.50" XL
20.44"	2	Right	1.50"-28	1.62"	2.25"	N/A	GS9734R	CRK11910B CRK9790AB	Spicer 16.50" XL
21.09"	1	Left	1.50"-10	1.50"	2.22"	N/A	CS685L	CRK2089B CRK2088AB CRK2287B	Multiple Apps. 16.50"
21.09"	1	Right	1.50"-10	1.50"	2.22"	N/A	CS684R	CRK2089B CRK2088AB CRK2287B	Multiple Apps. 16.50"
21.13"	3	Left	1.50"-10	1.50"	2.22"	2.66"	CS1411L	CRK2469B	Spicer 12.25"
21.13"	3	Right	1.50"-10	1.50"	2.22"	2.66"	CS1410R	CRK2469B	Spicer 12.25"
21.13"	1	Left	1.62"-37	1.62"	2.16"	N/A	CS2099L	CRK2090B CRK2122B	Fruehauf 16.50"
21.13"	1	Right	1.62"-37	1.62"	2.16"	N/A	CS2100R	CRK2090B CRK2122B	Fruehauf 16.50"
22.31"	3	Left	1.50"-10	1.50"	1.24"	2.22"	CS2493L	CRK2494B	Eaton 12.25"
22.31"	3	Right	1.50"-10	1.50"	1.24"	2.22"	CS2492R	CRK2494B	Eaton 12.25"
22.88"	1	Left	1.50"-10	1.50"	2.22"	N/A	CS4884L	CRK2089B CRK2088AB CRK2287B	
22.88"	1	Right	1.50"-10	1.50"	2.22"	N/A	CS4885R	CRK2089B CRK2088AB CRK2287B	
23.19"	4	Left	1.50"-28	1.62"	2.22"	N/A	GS10905L	CRK9790AB	Spicer 12.25"
23.19"	4	Right	1.50"-28	1.62"	2.22"	N/A	GS10906R	CRK9790AB	Spicer 12.25"
23.25"	3	Left	1.50"-10	1.50"	2.22"	2.66"	CS1423L	CRK2469B	Spicer 12.25"
23.25"	3	Right	1.50"-10	1.50"	2.22"	2.66"	GS1422R	CRK2469B	Spicer 12.25"
23.44"	1	Left	1.50"-28	1.50"	1.63"	2.22"	CS3856L	CRK2287B	Spicer 16.50"
23.44"	1	Right	1.50"-28	1.50"	1.63"	2.22"	CS3857R	CRK2287B	Spicer 16.50"
23.50"	2	Left	1.50"-10	1.50"	1.63"	2.22"	GS5520L	CRK2287B	Spicer 16.50" XL
23.50"	2	Right	1.50"-10	1.50"	1.63"	2.22"	CS5521R	CRK2287B	Spicer 16.50" XL

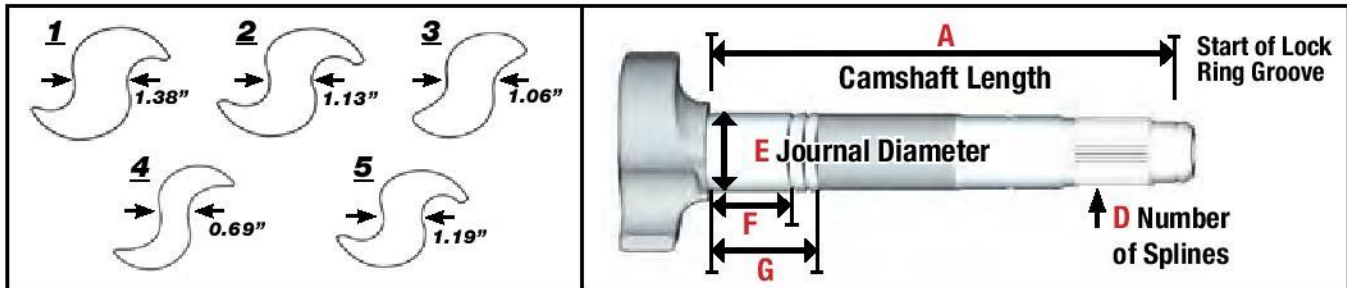

A	B	C	D	E	F	G	Camshaft Part #	CRK Kit	Manufacturer and Brake Size
Camshaft Length	Head Type	Left or Right	Spline Size and Num. of Splines	Journal Dia.	Length to 1st Groove	Length to 2nd Groove			
23.56"	2	Left	1.50"-28	1.50"	1.63"	2.22"	CS5526L	CRK2287B	Spicer 16.50" XL
23.56"	2	Right	1.50"-28	1.50"	1.63"	2.22"	CS5527R	CRK2287B	Spicer 16.50" XL
23.56"	2	Left	1.50"-28	1.62"	2.25"	N/A	GS9735L	CRK11910B CRK9790AB	Spicer 16.50" XL
23.56"	2	Right	1.50"-28	1.62"	2.25"	N/A	GS9736R	CRK11910B CRK9790AB	Spicer 16.50" XL
23.75"	1	Left	1.50"-10	1.62"	2.22"	N/A	GS4721L	CRK2696AB	Eaton 16.50"
23.75"	1	Right	1.50"-10	1.62"	2.22"	N/A	GS4720R	CRK2696AB	Eaton 16.50"
23.75"	2	Left	1.50"-10	1.62"	2.16"	21.44"	CS5496L	CRK2696AB	Eaton 16.50"
23.75"	2	Right	1.50"-10	1.62"	2.16"	21.44"	CS5497R	CRK2696AB	Eaton 16.50"
23.75"	2	Left	1.50"-28	1.62"	2.22"	N/A	CS9059L	CRK2696AB	Eaton 16.50" ES
23.75"	2	Right	1.50"-28	1.62"	2.22"	N/A	CS9060R	CRK2696AB	Eaton 16.50" ES
23.88"	1	Left	1.62"-37	1.62"	2.22"	N/A	GS3861L	CRK2090B CRK2122B	Fruehauf 16.50"
23.88"	1	Right	1.62"-37	1.62"	2.22"	N/A	GS3862R	CRK2090B CRK2122B	Fruehauf 16.50"
23.93"	4	Left	1.50"-28	1.62"	2.22"	N/A	GS10907L	CRK9790AB	Spicer 12.25"
23.93"	4	Right	1.50"-28	1.62"	2.22"	N/A	GS10908R	CRK9790AB	Spicer 12.25"
24.00"	1	Left	1.50"-10	1.50"	2.22"	N/A	GS4717L	CRK2089B CRK2088AB CRK2287B	Multiple Apps. 16.50"
24.00"	1	Right	1.50"-10	1.50"	2.22"	N/A	GS4716R	CRK2089B CRK2088AB CRK2287B	Multiple Apps. 16.50"
24.06"	5	Left	1.50"-28	1.62"	1.70"	1.97"	CS5510L	CRK9078B CRK9079B	Meritor 16.50" P, Q,
24.06"	5	Right	1.50"-28	1.62"	1.70"	1.97"	CS5511R	CRK9078B CRK9079B	Meritor 16.50" P, Q,
24.06"	2	Left	1.50"-28	1.50"	1.63"	2.22"	CS9100L	CRK2287B	Spicer 16.50" XL
24.06"	2	Right	1.50"-28	1.50"	1.63"	2.22"	CS9101R	CRK2287B	Spicer 16.50" XL
24.13"	2	Left	1.50"-28	1.62"	2.25"	N/A	GS10909L	CRK11910B CRK9790AB	Spicer 16.50" XL
24.13"	2	Right	1.50"-28	1.62"	2.25"	N/A	GS10910R	CRK11910B CRK9790AB	Spicer 16.50" XL
26.25"	2	Left	1.50"-28	1.62"	2.25"	N/A	GS11860L	CRK11910B CRK9790AB	Spicer 16.50" XL
26.25"	2	Right	1.50"-28	1.62"	2.25"	N/A	GS11861R	CRK11910B CRK9790AB	Spicer 16.50" XL
26.25"	1	Left	1.50"-10	1.50"	2.22"	N/A	GS7217L	CRK2287B	Spicer 16.50"
26.25"	1	Right	1.50"-10	1.50"	2.22"	N/A	GS7218R	CRK2287B	Spicer 16.50"



CAM REPAIR KITS



**Tightest
Tolerances**

**Durability
and Long Life**



Heavy Duty Cam Repair Kits Identification Requires 3 Simple Steps

- A. Identify the camshaft.**
- B. Identify the CRK options.**
- C. Use the CRK picture to confirm the CRK kit required.**

A		B
SilverbackHD Left Camshaft Part #	SilverbackHD Right Camshaft Part #	SilverbackHD CRK Part #
CS685L	CS684R	CRK2089B CRK2088AB CRK2287B
CS1148CL	CS1147CR	CRK3993BB
CS1411L	CS1410R	CRK2469B
CS1423L	CS1422R	CRK2469B
CS1425AL	CS1424AR	CRK2089B CRK2088AB CRK2287B
CS1563L	CS1564R	CRK2090B CRK2122B
CS1776L	CS1775R	CRK10897B
CS2099L	CS2100R	CRK2090B CRK2122B
CS2493L	CS2492R	CRK2494B
CS3854L	CS3855R	CRK2287B
CS3856L	CS3857R	CRK2287B
CS3861L	CS3862R	CRK2090B CRK2122B
CS4717L	CS4716R	CRK2089B CRK2088AB CRK2287B
CS4721L	CS4720R	CRK2696AB
CS4884L	CS4885R	CRK2089B CRK2088AB CRK2287B
CS4892L	CS4893R	CRK2089B CRK2088AB CRK2287B
CS5003L	CS5004R	CRK3993BB
CS5492L	CS5493R	CRK2125B
CS5496L	CS5497R	CRK2696AB
CS5506L	CS5507R	CRK9078B CRK9079B CRK3520B
CS5508L	CS5509R	CRK9078B CRK9079B
CS5510L	CS5511R	CRK9078B CRK9079B
CS5520L	CS5521R	CRK2287B
CS5524L	CS5525R	CRK2287B

A		B
SilverbackHD Left Camshaft Part #	SilverbackHD Right Camshaft Part #	SilverbackHD CRK Part #
CS5526L	CS5527R	CRK2287B
CS7217L	CS7218R	CRK2287B
CS7219L	CS7220R	CRK2287B
CS9059L	CS9060R	CRK2696AB
CS9100L	CS9101R	CRK2287B
CS9649L	CS9650R	CRK3993BB
CS9655L	CS9656R	CRK3993BB
CS9657L	CS9658R	CRK3993BB
CS9659L	CS9660R	CRK3993BB
CS9661L	CS9662R	CRK3993BB
CS9663L	CS9664R	CRK3993BB
CS9665L	CS9666R	CRK3993BB
CS9669L	CS9670R	CRK3993BB
CS9671L	CS9672R	CRK3993BB
CS9673AL	CS9674AR	CRK3993BB
CS9675L	CS9676R	CRK3993BB
CS9677L	CS9678R	CRK3993BB
CS9681L	CS9682R	CRK3993BB
CS9683L	CS9684R	CRK3993BB
CS9731L	CS9732R	CRK11910B CRK9790AB
CS9733L	CS9734R	CRK11910B CRK9790AB
CS9735L	CS9736R	CRK11910B CRK9790AB
CS10905L	CS10906R	CRK9790AB
CS10907L	CS10908R	CRK9790AB
CS10909L	CS10910R	CRK11910B CRK9790AB
CS11529L	CS11528R	CRK3993BB
CS11860L	CS11861R	CRK11910B CRK9790AB
CS11864L	CS11865R	CRK11897B
CS11866L	CS11867R	CRK11897B

CRK2086BB

Brake Size	16.50" and 18.00"	Brake App.	Meritor
------------	-------------------	------------	---------

Info. 16.50" and 18.00" P brake drive axles



CRK2087B

Brake Size	16.50"	Brake App.	Standard Forge
------------	--------	------------	----------------

Info. 16.50" early model Standard Forge and Kershaw



CRK2088AB

Brake Size	16.50"	Brake App.	Meritor
------------	--------	------------	---------

Info. 16.50" P series trailer brakes late model Meritor



CRK2089B

Brake Size	16.50"	Brake App.	Eaton
------------	--------	------------	-------

Info. 16.50" brakes 5.00" round axle early model



CRK2090B

Brake Size	12.25" and 16.50"	Brake App.	Fruehauf
------------	-------------------	------------	----------

Info. 16.50" and 12.25" Fruehauf late model Pro-Par axles



CRK2122B

Brake Size	16.50"	Brake App.	Fruehauf
------------	--------	------------	----------

Info. 16.50" Fruehauf early model Pro-Par axles



CRK2125B

Brake Size	15.00" and 16.50"	Brake App.	Eaton
------------	-------------------	------------	-------

Info. 15.00" and 16.50" brakes



CRK2287B

Brake Size	16.50"	Brake App.	Spicer and Standard Forge
------------	--------	------------	---------------------------

Info. 16.50" late models with weld on spiders



CRK2469B

Brake Size	12.25"	Brake App.	Spicer and Standard Forge
------------	--------	------------	---------------------------

Info. 12.25" late model axles



CRK2494B			
Brake Size	12.25"	Brake App.	Eaton
Info.	12.25" late model axles		
			

CRK2680B			
Brake Size	16.50"	Brake App.	Spicer
Info.	16.50" brakes		
			

CRK2696AB			
Brake Size	16.50"	Brake App.	Eaton
Info.	16.50" late model trailer		
			

CRK3520AB			
Brake Size	16.50"	Brake App.	Meritor
Info.	16.50" 4000-6000 series trailer late model		
			

CRK3993BB			
Brake Size	15.00" and 16.50"	Brake App.	Meritor
Info.	15.00" and 16.50" Q and Q+ drive axles		
			

CRK5094AB			
Brake Size	16.50"	Brake App.	Meritor Mack App.
Info.	16.50" drive axle		
			

CRK5307B			
Brake Size	12.25"	Brake App.	Spicer
Info.	12.25" U brake		
			

CRK5501B			
Brake Size	15.00" and 16.50"	Brake App.	Eaton
Info.	15.00" reduced envelope and drive axle 16.50" extended service brakes		
			

CRK9078B			
Brake Size	16.50"	Brake App.	Meritor
Info.	16.50" Q and Q+ trailer brakes press in spider bushing		
			

CRK9079B

Brake Size	16.50"	Brake App.	Meritor
Info.	16.50" Q and Q+ trailer brakes bolt on spider bushing		



CRK9080B

Brake Size	16.50"	Brake App.	Meritor
Info.	16.50" P and Q drive axle 2.50" offset spider		



CRK9790AB

Brake Size	12.25" and 16.50"	Brake App.	Spicer
Info.	12.25" and 16.50" brakes with 1.63" journal		



CRK9791B

Brake Size	16.50"	Brake App.	Hendrickson Intraax®
Info.	16.50" brakes 1.88" seal/bushing OD		



CRK10897B

Brake Size	15.00" and 16.50"	Brake App.	Eaton
Info.	15.00" reduced envelope and drive axle 16.50" extended service brakes		



CRK11450B

Brake Size	16.50"	Brake App.	Hendrickson Intraax®
Info.	16.50" brakes 2.00" seal/bushing OD		



CRK11897B

Brake Size	16.50"	Brake App.	Hendrickson Intraax®
Info.	16.50" brakes 1.50" journal		



CRK11910B

Brake Size	12.25" and 16.50"	Brake App.	Spicer
Info.	12.25" and 16.50" brakes with 1.63" journal		



* Bronze Bushing



SLACK ADJUSTERS



**All Makes
Coverage**

**Designed for
Durability**

**Lowest
Cost per Mile**

Heavy Duty Auto Slack Adjuster Identification Requires 5 Simple Steps

A. Find correct auto slack style.



H Style: Hardware styles

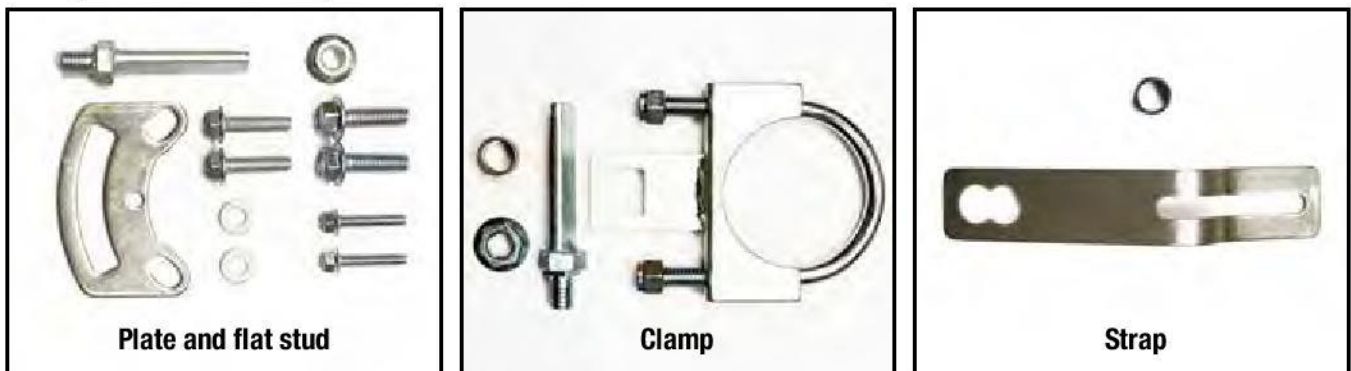



A	B	C	D	H Style: Hardware Style M Style: Pawl Location	Application	Replaces	SilverbackHD Part #
Style	Arm(s) Length	Spline Size	Spline Count				
B Style	5.50"	1.50"	10		Drive or Trailer	065700, 065170	ASB65700
B Style	5.50"	1.50"	28		Drive or Trailer	065247, 065174	ASB65247
B Style	6.00"	1.50"	10		Drive or Trailer	065344, 065172	ASB65344
B Style	6.00"	1.50"	28		Drive or Trailer	065175, 065176	ASB65175
B Style	6.00"	1.63"	37		Trailer Fruehauf	065177, 065179	ASB65179
G Style	5.50"	1.25"	10		Steer Axle (Steer)	AS1136	ASG1136
G Style	5.50"	1.25"	24		Steer Axle (Steer)	AS1138	ASG1138
G Style	5.50"	1.50"	10		Drive Axle and Steer Axle	AS1132	ASG1132
G Style	5.50"	1.50"	10		Trailer Axle	AS1146	ASG1146
G Style	5.50"	1.50"	28		Drive Axle and Steer Axle	AS1140	ASG1140
G Style	6.00"	1.50"	10		Drive Axle (Rear)	AS1133	ASG1133
G Style	6.00"	1.50"	10		Trailer Axle	AS1147	ASG1147
G Style	6.00"	1.50"	28		Drive Axle (Rear)	AS1141	ASG1141
G Style	6.00"	1.50"	28		Trailer Axle	AS1150	ASG1150
G Style	6.00"	1.63"	37		Trailer Fruehauf	AS1144	ASG1144
G Style	6.50"	1.50"	28		Drive Axle (Rear)	AS1142	ASG1142
H Style	5.00", 6.00"	1.50"	10	Strap	Drive Axle (Drive Mack)	40010142	ASH40010142
H Style	5.00", 6.00"	1.50"	28	Strap	Drive Axle (Drive)	40010140	ASH40010140
H Style	5.50"	1.25"	10	Clamp	Steer Axle (Std)	40010001	ASH40010001
H Style	5.50"	1.25"	10	Strap	Steer Axle (Non-Std)	40010013	ASH40010013
H Style	5.50"	1.50"	10	Strap	Drive Axle (Drive)	40010143	ASH40010143
H Style	5.50"	1.50"	10	Strap	Drive Axle (Drive K/W 8 Bag)	40010155	ASH40010155
H Style	5.50"	1.50"	10	Plate and Flat Stud	Trailer 16.50"	40010215	ASH40010215
H Style	5.50"	1.50"	28	Clamp	Steer Axle (Std)	40010008	ASH40010008
H Style	5.50"	1.50"	28	Strap	Steer Axle (Std)	40010070	ASH40010070
H Style	5.50"	1.50"	28	Strap	Drive Axle (Drive Mack)	40010141	ASH40010141
H Style	5.50"	1.50"	28	Strap	Drive Axle (Drive Mack), S-ABA	40010141	ASH40020231
H Style	5.50"	1.50"	28	Strap	Drive Axle (Drive K/W 8 Bag)	40010156	ASH40010156
H Style	5.50"	1.50"	28	Plate and Flat Stud	Trailer 16.50"	40010211	ASH40010211
H Style	5.50"	1.50"	28	Plate and Flat Stud	Trailer 16.50", S-ABA	40020211	ASH40020211
H Style	5.50"	1.63"	37	Plate and Flat Stud	Trailer 16.50"	40010145	ASH40010213
H Style	6.00"	1.50"	10	Clamp	Drive Axle (Drive Mack)	40010145	ASH40010145
H Style	6.00"	1.50"	10	Plate and Flat Stud	Trailer 16.50"	40010216	ASH40010216
H Style	6.00"	1.50"	10	Plate and Flat Stud	Trailer 12.25"	40010306	ASH40010306
H Style	6.00"	1.50"	28	Clamp	Drive Axle (Drive Mack)	40010144	ASH40010144
H Style	6.00"	1.50"	28	Plate and Flat Stud	Trailer 16.50"	40010212	ASH40010212
H Style	6.00"	1.50"	28	Plate and Flat Stud	Trailer 16.50", S-ABA	40020212	ASH40020212
H Style	6.00"	1.50"	28	Plate and Flat Stud	Trailer 12.25"	40010305	ASH40010305
H Style	6.00"	1.63"	37	Plate and Flat Stud	Trailer 16.50"	40010214	ASH40010214
M Style	5.50"	1.50"	10	Unhanded or 3	Steer/Drive/Trailer Axle	R801041	ASM801041
M Style	5.50"	1.50"	28	Unhanded or 3	Steer/Drive/Trailer Axle	R801073	ASM801073
M Style	5.50"	1.50"	28	Unhanded or 3	Steer	R801079	ASM801079
M Style	5.50"	1.50"	28	Handed Type A or 1	Steer/Drive/Trailer Axle	R802446	ASM802446
M Style	5.50"	1.50"	28	Handed Type B or 2	Steer/Drive/Trailer Axle	R802447	ASM802447
M Style	6.00"	1.50"	10	Unhanded or 3	Steer/Drive/Trailer Axle	R801042	ASM801042
M Style	6.00"	1.50"	28	Unhanded or 3	Drive/Trailer Axle	R801074	ASM801074
M Style	6.00"	1.50"	28	Handed Type A or 1	Drive/Trailer Axle	R802486	ASM802486
M Style	6.00"	1.50"	28	Handed Type B or 2	Steer/Drive/Trailer Axle	R802487	ASM802487
M Style	6.00"	1.63"	37	Unhanded or 3	Trailer Fruehauf	R801102	ASM801102

Heavy Duty Manual Slack Adjuster Identification Requires 6 Simple Steps

- A. Measure the arm length to the first hole.**
- B. Measure the arm length to the second hole.**
- C. Measure the arm length to the third hole.**
- D. Measure spline diameter.**
- E. Count number of splines.**
- F. Use chart to find the correct manual slack adjuster.**

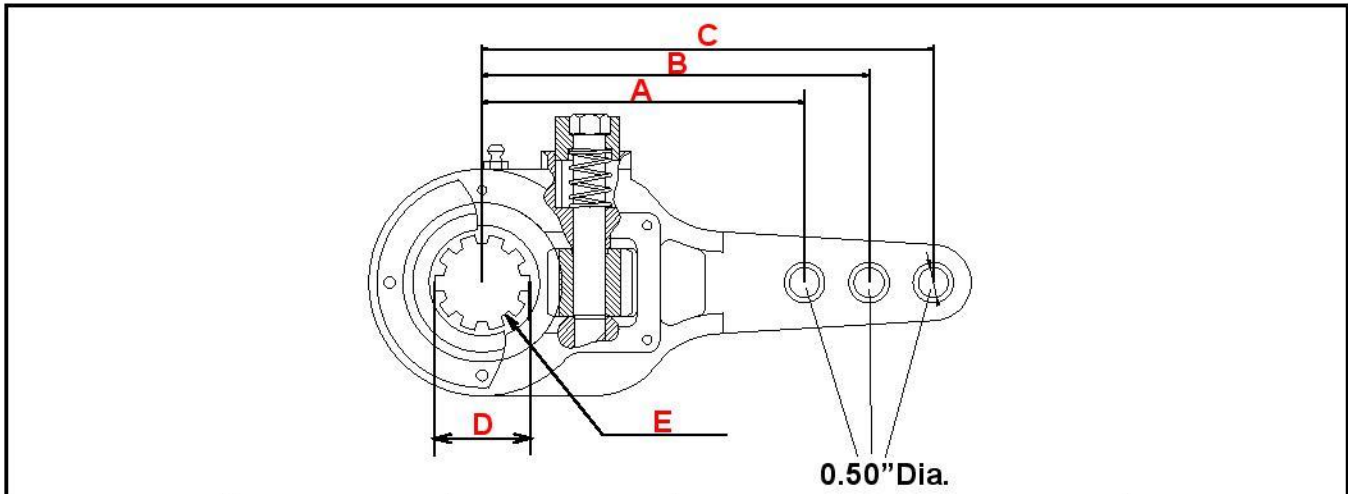

A	B	C	D	E	SilverbackHD Part #
Arm Length	Arm Length	Arm Length	Spline Diameter	Num. of Splines	
5.00"	6.00"	7.00"	1.50"	28	MS44071
5.00"	6.00"	7.00"	1.50"	10	MS47008
5.50"	6.50"	N/A	1.50"	10	MS52070
5.50"	6.50"	N/A	1.50"	28	MS44064
6.00"	N/A	N/A	1.58"	37	MS52080





AIR CHAMBERS



**1,000,000 Cycle
Tested**

**Greater
Dependability**

**Full Drum and
Disc Coverage**

Heavy Duty Complete Air Brake Chamber Identification Requires 7 Simple Steps

A. Count diaphragms.

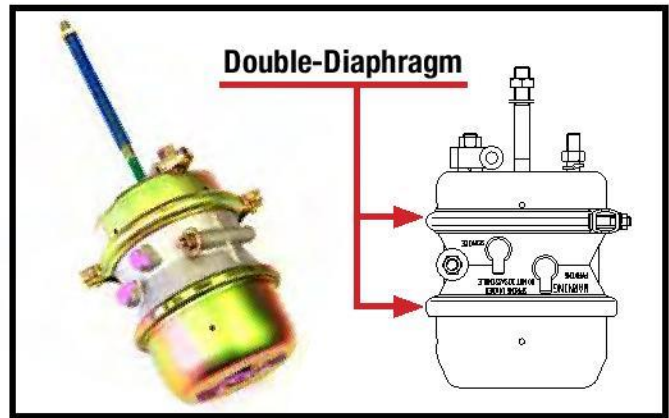
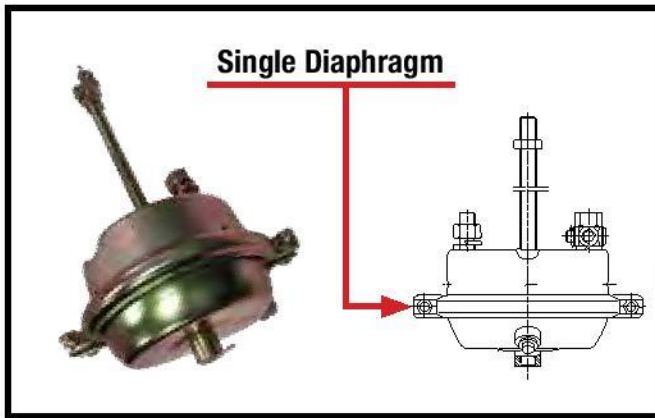

Chambers

B. Identify the pushrod style.

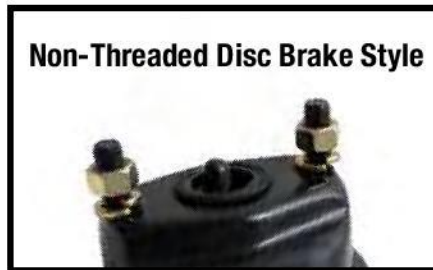
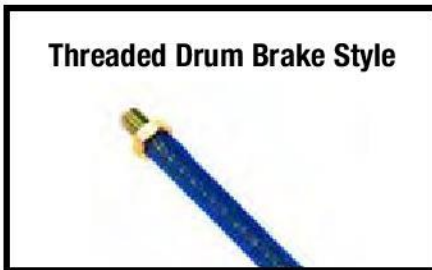

C. Measure the outside to outside diameter of the clamps closest to the mounting studs, but never in the clamp bolt area.

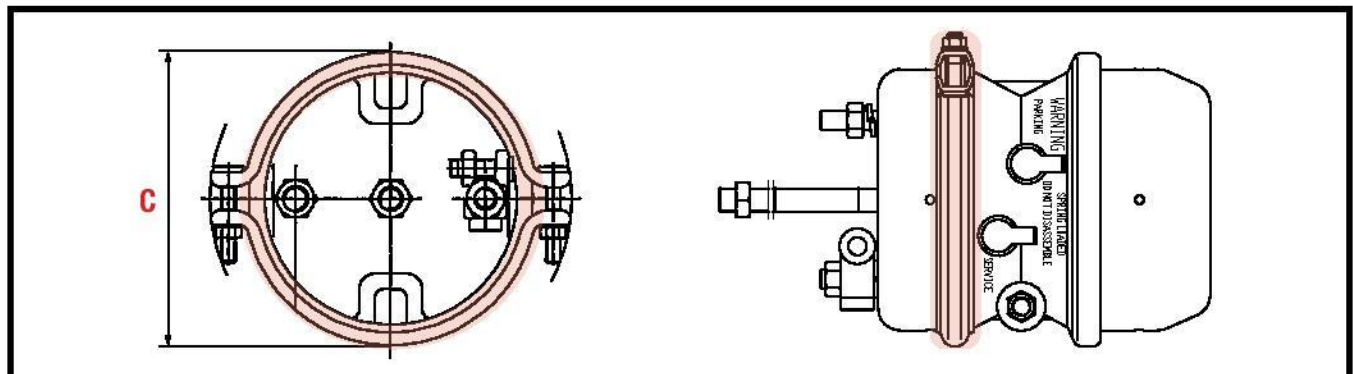

D. Measure the outside to outside diameter of the clamps farthest from the mounting studs, but never in the clamp bolt area.

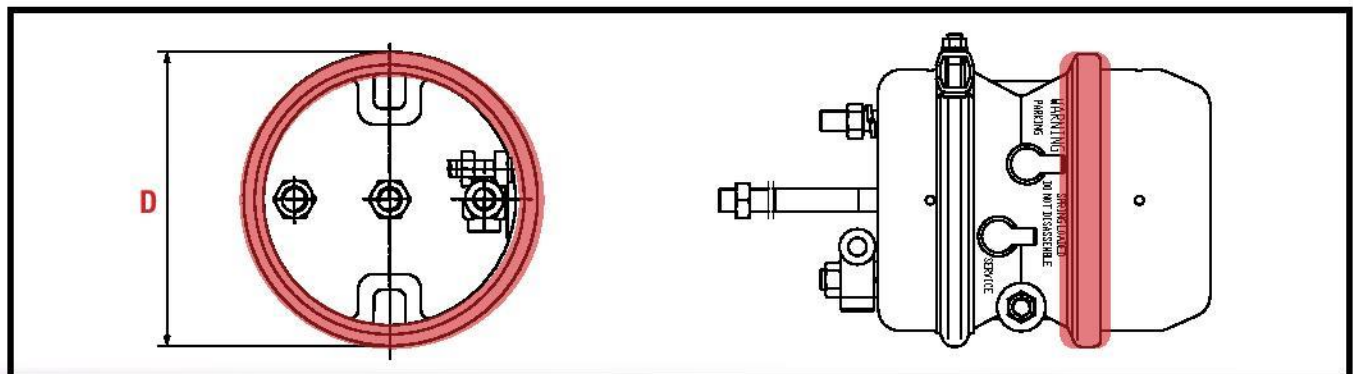

E. Identify air port hole shape.

F. Refer to the notes for more details.

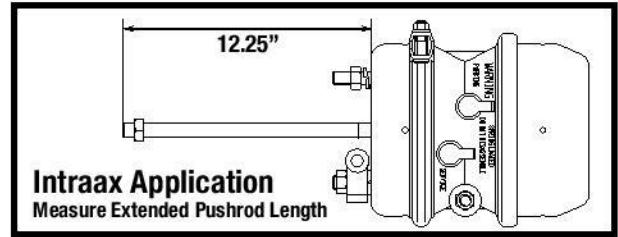

G. Use chart to find the correct air brake chamber.

A	B	C	D	E	F	SilverbackHD Part #
Diaphragm: Single or Double	Pushrod Type	Clamp(s) OD: Closest to Mounting Studs	Clamp(s) OD: Farthest to Mounting Studs	Ports Shape	Notes	
Double	No Pushrod	7.25"	7.25"	Round	Piggyback Kit	2424PBK
Double	No Pushrod	7.25"	8.25"	Round	Piggyback Kit	2430PBK
Double	No Pushrod	8.25"	8.25"	Round	Piggyback Kit	3030PBK
Double	No Pushrod	8.25"	8.25"	Square	Piggyback Kit	3030PBKLS
Double	Non-Threaded	6.69"	7.32"	Round	Air Disc Brake Complete	1824ADSB
Double	Non-Threaded	6.89"	7.32"	Round	Air Disc Brake Complete	2024ADSB
Double	Threaded	7.25"	7.25"	Round	Standard Drum Brake Complete	2424SB
Double	Threaded	7.25"	8.25"	Round	Standard Drum Brake Complete	2430SB
Double	Threaded	8.25"	8.25"	Round	Standard Drum Brake Complete	3030SB
Double	Threaded	8.25"	8.25"	Round	Standard Drum Brake Complete Intraax 12.25" Pushrod	3030SB-INT
Double	Threaded	8.25"	8.25"	Square	Long Stroke Springbrake Complete	3030SBSL
Double	Threaded	8.25"	8.25"	Square	Long Stroke Springbrake Complete Intraax 12.25" Pushrod	3030SBSL-INT
Single	Non-Threaded	6.85"	N/A	Round	Air Disc Service Chamber	18ADSC
Single	Non-Threaded	6.97"	N/A	Round	Air Disc Service Chamber	20ADSC
Single	Threaded	5.25"	N/A	Round	Service Chamber	09SC
Single	Threaded	5.75"	N/A	Round	Service Chamber	12SC
Single	Threaded	6.25"	N/A	Round	Service Chamber	16SC
Single	Threaded	6.75"	N/A	Round	Service Chamber	20SC
Single	Threaded	7.25"	N/A	Round	Service Chamber	24SC
Single	Threaded	8.25"	N/A	Round	Service Chamber	30SC

Air Brake Chamber Miscellaneous Parts



Air Port Plug



Clevis Assembly



End Plug with Tether



Clevis Pin



Release Bolt Assembly



Clamp



Diaphragm

Description	SilverbackHD Part #
Air Port Plug	APPL
Type 9 Clamp	09CL
Type 12 Clamp	12CL
Type 16 Clamp	16CL
Type 20 Clamp	20CL
Type 24 Clamp	24CL
Type 30 Clamp	30CLW
Clevis Assembly 1/2" Rod x 1/2" Pin	5050CV
Clevis Assembly 5/8" Rod x 1/2" Pin	5850CV
Clevis Assembly 5/8" Rod x 5/8" Pin	5858CV
Clevis Pin 1/2" x 1-3/4" Long	50CP
Clevis Pin 5/8" x 1-3/4" Long	58CP
Type 9 Diaphragm	09D
Type 12 Diaphragm	12D
Type 16 Diaphragm	16D
Type 20 Diaphragm	20D
Type 24 Diaphragm	24D
Type 30 Diaphragm	30D
End Plug with Tether	SBECPL
Release Bolt Assembly	3030RB



HYDRAULIC DISC PADS



**Ceramic
Enhanced**

Long Life

**Quiet
No Squealing**



Heavy Duty Hydraulic Brake Pad Identification Requires 4 Simple Steps

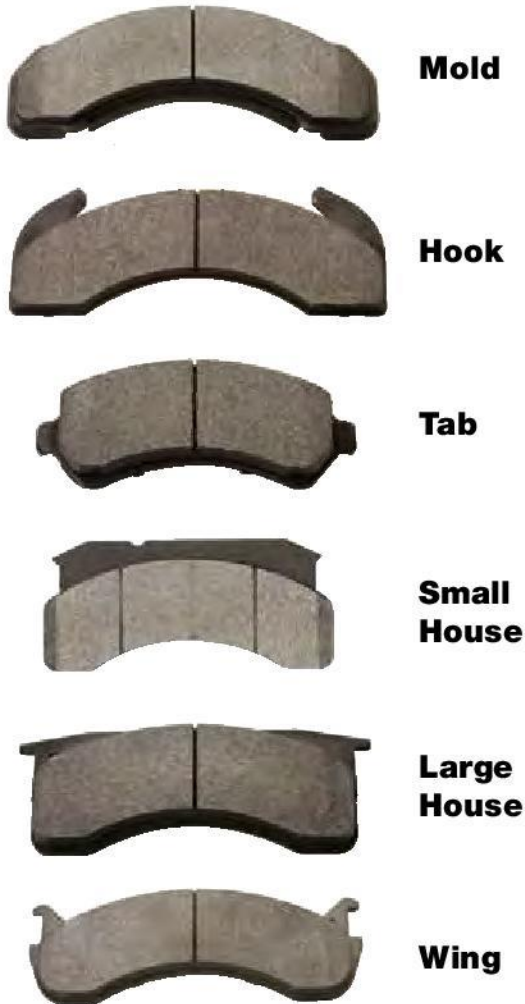

Overall Length



Overall Height

**Hyd.
Disc
Brake**

- A. Identify the style of the pads.**
- B. Measure pad overall length.**
- C. Measure pad overall height.**
- D. Check identifiers.**

NOTE:

**When measuring length and width:
INCLUDE the shim.
DO NOT INCLUDE squealer tab.**

A	B	C	D	SilverbackHD Caliper Part #	SilverbackHD Pad Set Part # (SD: Severe Duty)
Style Pads	Pad Overall Length	Pad Overall Height	Identifiers		
Hook style Tab style	269.5mm (10.61") Hook pad 205.0mm (8.07") Tab pad	100.0mm (3.93") 80.0mm (3.15")		55CL250	D225-7808CE D225-7808SD
Large House style	240.0mm (9.45")	88.6mm (3.49")	Replaces D1032 and D1418	13CL706-7 14CL684012-3 14CL684014-5	D769-7636CE D769-7636SD
Mold style Tab style	254.0mm (10.03") Mold pad 205.0mm (8.07") Tab pad	97.5mm (3.83") 80.0mm (3.15")		55CL314	D184-7806CE D184-7806SD
Small house style	213.4mm (8.40")	101.5mm (3.96")		55CL251	D224-7807CE D224-7807SD
Small house style	228.6mm (9.00")	102.6mm (4.04")		55CL252	D236-7809CE D236-7809SD
Wing style	222.0mm (8.74")	64.5mm (2.54")		14CL7076 14CL7077	D1066-7972CE D1066-7972SD
Wing style	244.1mm (9.61")	85.1mm (3.35")	Fits 73.0mm caliper plate/ friction 26.8mm (1.05")	55CL850	D786-7655CE-THICK D786-7655SD-THICK
Wing style	244.1mm (9.61")	85.1mm (3.35")	Fits 66.0mm caliper plate/ friction 20.3mm (0.80")	55CL849	D786A-7654CE-THIN D786A-7654SD-THIN



HYDRAULIC DISC CALIPERS



**All New
No Cores**

**Precision
Machined
Components**

**Excellent
Life Cycle**

Heavy Duty Hydraulic Brake Caliper Identification Requires 5 Simple Steps



A. Identify the style.

- **Single Slot:** Bendix
- **Twin Slot:** Bosch or TRW
- **Large Cavity:** Dayton or Meritor

B. Count the pistons.

- **Two:** Bendix, Bosch, Dayton, TRW
- **Four:** Meritor

C. Measure the piston diameter.

- **Standard (2.50", 2.60", 2.88"):** Bendix or Dayton
- **Metric (60, 66, 70, 73mm):** Bosch, Meritor, or TRW

D. Count the TOTAL mounting holes.

- **None:** Bendix or Dayton
- **Two:** Bosch or TRW
- **Four or Six:** Meritor

E. Determine right or left.

Some calipers will have an OE casting number

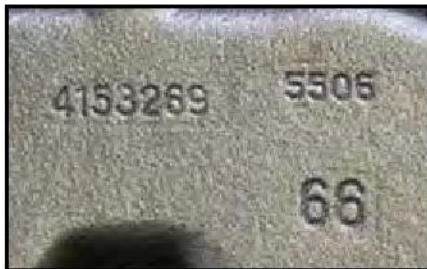

Casting Number



Piston Dia. Measurement



**Repair Kit HK11HH754
(55CL849 & 55CL850)**

A	B	C	D	E	Casting #	Mfr. Style	SilverbackHD Disc Pad Part # (SD: Severe Duty)	SilverbackHD Caliper Part #	
Style (Top Opening)	Piston Count	Piston Dia.	Mounting Holes	Side					
Single Slot	Two	2.60"	None	Right/Left	4151733	Bendix	D184-7806CE D184-7806SD	55CL314	
Single Slot	Two	2.88"	None	Right/Left	4150344 4150844	Bendix	D225-7808CE D225-7808SD	55CL250	
Twin Slot	Two	60.0mm	2 (1 each side)	Right	130307 142298	TRW	D1066-7972CE D1066-7972SD	14CL7076	
Twin Slot	Two	60.0mm	2 (1 each side)	Left	130307 142298	TRW	D1066-7972CE D1066-7972SD	14CL7077	
Twin Slot	Two	66.0mm	2 (1 each side)	Right/Left	4153269	Bosch	D786A-7654CE-THIN D786A-7654SD-THIN	55CL849	Repair Kit HK11HH754
Twin Slot	Two	73.0mm	2 (1 each side)	Right/Left	4153222	Bosch	D786-7655CE-THICK D786-7655SD-THICK	55CL850	Repair Kit HK11HH754
Large Cavity	Two	2.50"	None	Right/Left	22602	Dayton	D224-7807CE D224-7807SD	55CL251	
Large Cavity	Two	2.88"	None	Right/Left	0456, 0578	Dayton	D236-7809CE D236-7809SD	55CL252	
Large Cavity	Four	64.0mm	4 (2 each side)	Right/Left	595-597, 581-583	Meritor	D769-7636CE D769-7636SD	14CL684014-5	
Large Cavity	Four	70.0mm	4 (2 each side)	Right/Left	595-597, 581-583	Meritor	D769-7636CE D769-7636SD	14CL684012-3	
Large Cavity	Four	70.0mm	6 (3 each side)	Right/Left	595-597, 9187, 9188	Meritor	D769-7636CE D769-7636SD	13CL706-7	

Hyd. Disc Brake



HYDRAULIC DISC ROTORS



**High Carbon
Cast Iron**

**GEOMET®
Rust Protection**

**Precision
Balanced**



Heavy Duty Hydraulic Brake Rotor Identification Requires 8 Simple Steps



- A. Identify the style: Flat, Hat and U type.**
- B. Measure overall diameter.**
- C. Measure pilot diameter.**
- D. Measure bolt circle diameter from center of bolt holes.**
- E. Count bolt holes.**
- F. Measure overall depth.**
- G. Measure bolt hole size.**
- H. Measure thickness or see minimum thickness stamped or cast on rotor.**

Lastly, note whether it has any features such as ABS rings or ABS ring drill holes.

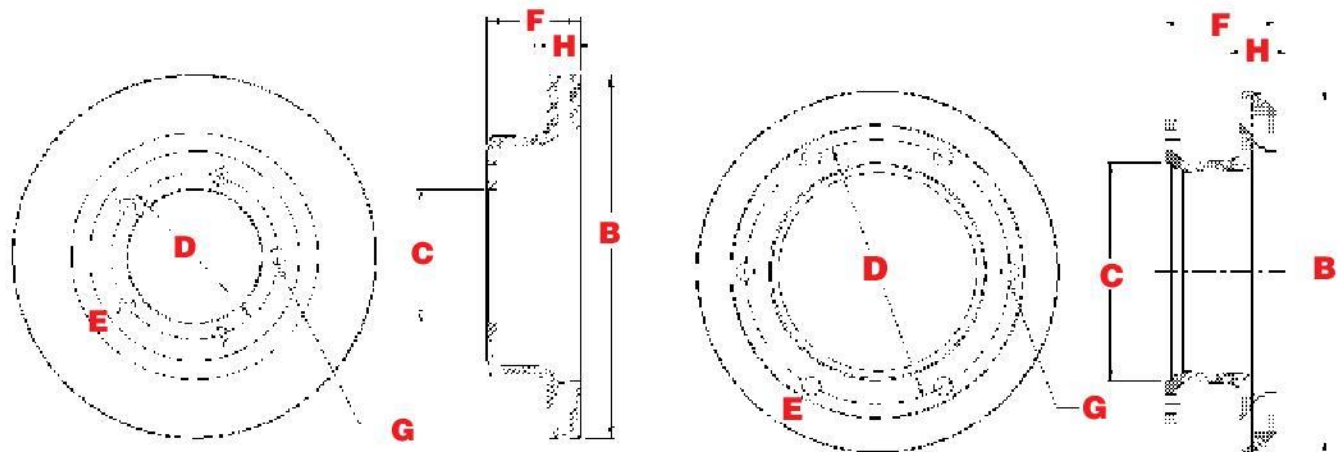

A	B	C	D	E	F	G	H	Special Info.	SilverbackHD Part #
Style	Overall Dia.	Pilot Dia.	Bolt Circle	Bolt Hole Qty.	Overall Depth	Bolt Hole Size	Disc Thickness		
Flat	389.9mm (15.35")	187.5mm (7.38")	219.7mm (8.65")	10	48.5mm (1.91")	13.5mm (0.53")	39.1mm (1.54")	c/w hardware	19HR996G
Hat	374.4mm (14.74")	137.2mm (5.40")	171.5mm (6.75")	5	96.5mm (3.80")	16.5mm (0.65")	34.0mm (1.34")		54HR102G
Hat	374.4mm (14.74")	137.2mm (5.40")	171.5mm (6.75")	6	96.5mm (3.80")	16.5mm (0.65")	34.0mm (1.34")		54HR104G
Hat	374.4mm (14.74")	137.2mm (5.40")	183.6mm (7.23")	6	96.5mm (3.80")	19.8mm (0.78")	34.0mm (1.34")	Holes drilled for ABS	54HR105G
Hat	381.0mm (15.00")	137.2mm (5.40")	171.5mm (6.75")	5	88.9mm (3.50")	19.8mm (0.78")	36.6mm (1.44")	ABS ready	54HR769G
Hat	381.0mm (15.00")	137.2mm (5.40")	171.5mm (6.75")	6	88.9mm (3.50")	19.8mm (0.78")	36.6mm (1.44")	ABS ready	54HR770G
Hat	381.0mm (15.00")	152.4mm (6.00")	184.1mm (7.25")	10	81.3mm (3.20")	14.7mm (0.58")	36.6mm (1.44")	ABS ready	54HR773G
Hat	381.0mm (15.00")	152.4mm (6.00")	184.1mm (7.25")	10	112.8mm (4.44")	14.7mm (0.58")	36.6mm (1.44")	ABS ready	54HR771G
Hat	389.9mm (15.35")	139.5mm (5.49")	163.3mm (6.43")	10	124.0mm (4.88")	13.0mm (0.51")	39.1mm (1.54")		14HR1394G
Hat	390.7mm (15.38")	152.4mm (6.00")	184.2mm (7.25")	10	86.4mm (3.40")	14.7mm (0.58")	39.1mm (1.54")		54HR301G
Hat	390.7mm (15.38")	152.4mm (6.00")	184.2mm (7.25")	10	86.4mm (3.40")	14.7mm (0.58")	39.1mm (1.54")	ABS ready	54HR775G
U Type	381.0mm (15.00")	241.3mm (9.50")	285.8mm (11.25")	10	180.6mm (7.11")	26.9mm (1.06")	36.6mm (1.44")	ABS ready	61HR78AMG
U Type	390.9mm (15.39")	231.7mm (9.12")	285.8mm (11.25")	10	193.0mm (7.60")	23.9mm (0.94")	39.1mm (1.54")	ABS ready	54HR365G

Hyd. Disc Brake



AIR DISC PADS



**High Torque
Formula**

Low Rotor Wear

Long Pad Life



Heavy Duty Air Disc Brake Pad Identification Requires 3 Simple Steps

- A. Measure the overall length of the backing plate.**
- B. Measure the overall height of the steel plate.**
- C. Identify the backing plate design using pictures.**

A	B	Application	SilverbackHD Part # (SD: Severe Duty)
Overall Length	Overall Height		
175.5mm (6.91")	85.9mm (3.38")	Wabco PAN17	D1518-8727 D1518-8727SD
210.3mm (8.28")	92.7mm (3.65")	Wabco PAN19	D1438-8556 D1438-8556SD
210.3mm (8.28")	107.7mm (4.24")	Bendix ADB22X™	D1369-8479 D1369-8479SD
210.3mm (8.28")	108.0mm (4.25")	Wabco MAXXUS	D2061-9294
210.3mm (8.28")	109.7mm (4.32")	Wabco PAN22 / Maxx 22T	D1777-9007 D1777-9007SD
216.2mm (8.51")	111mm (4.37")	Meritor EX225L	D1370-8480 D1370-8480SD
247.1mm (9.73")	109.5mm (4.31")	Bendix SB7 and SN7	D1203-8323 D1203-8323SD
249.4mm (9.82")	116.6mm (4.59")	Meritor EX225	D1311-8426 D1311-8426SD
249.4mm (9.82")	117.9mm (4.64")	Meritor D-ELSA 2	D1310-8425
249.4mm (9.82")	118.1mm (4.65")	Meritor D-ELSA 1	D1407-8515
249.7mm (9.83")	109.5mm (4.31")	Meritor ELSA 225-3	D1708-8931 D1708-8931SD
249.7mm (9.83")	114.3mm (4.50")	Meritor D-LISA	D1312-8427



D1203-8323(SD)

Overall Length	247.1mm (9.73")	Overall Height	109.5mm (4.31")
----------------	-----------------	----------------	-----------------

Backing Plate Design

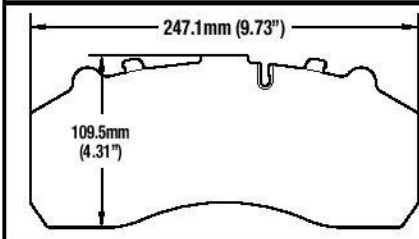

Friction Side

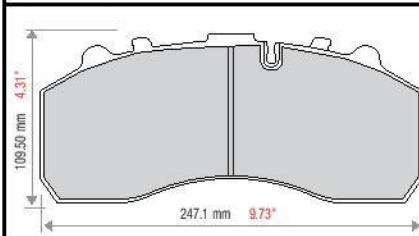

c/w Hardware Kits / HKD1203



D1310-8425

Overall Length	249.4mm (9.82")	Overall Height	117.9mm (4.64")
----------------	-----------------	----------------	-----------------

Backing Plate Design

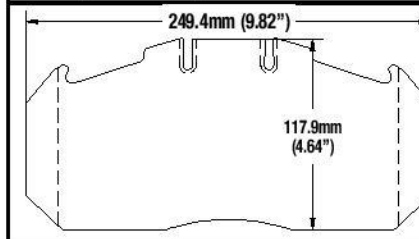

Friction Side

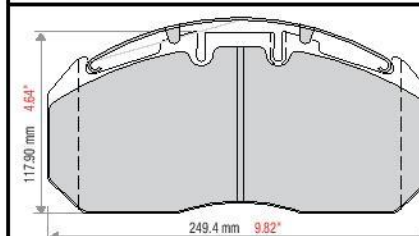

c/w Hardware Kits / HKD1310-D1407

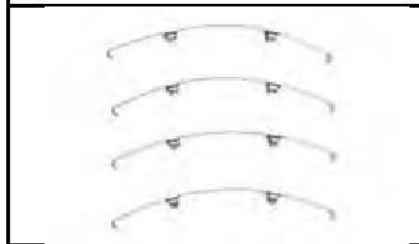

D1311-8426(SD)

Overall Length	249.4mm (9.82")	Overall Height	116.6mm (4.59")
----------------	-----------------	----------------	-----------------

Backing Plate Design

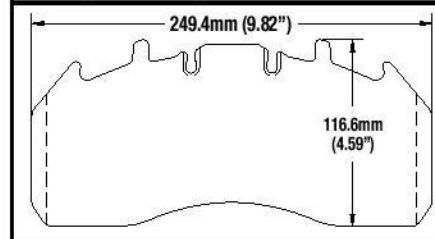

Friction Side

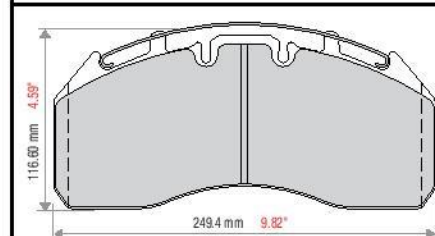

c/w Hardware Kits / HKD1311

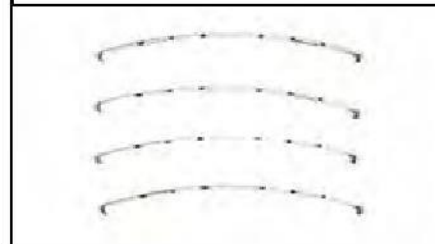

D1312-8427

Overall Length	249.7mm (9.83")	Overall Height	114.3mm (4.50")
----------------	-----------------	----------------	-----------------

Backing Plate Design

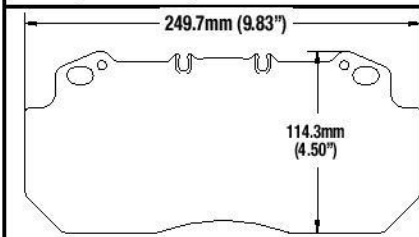

Friction Side

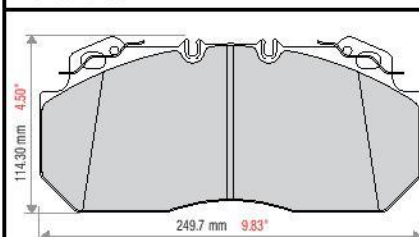

c/w Hardware Kits / HKD1312

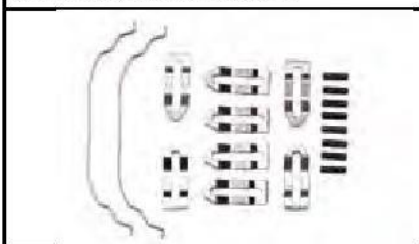

D1369-8479(SD)

Overall Length	210.3mm (8.28")	Overall Height	107.7mm (4.24")
----------------	-----------------	----------------	-----------------

Backing Plate Design

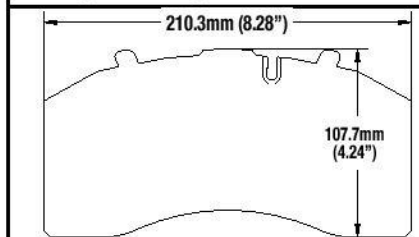

Friction Side

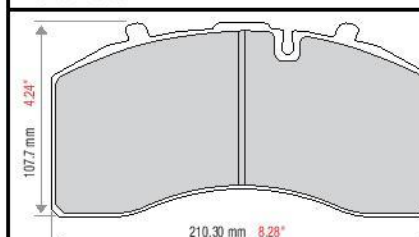

c/w Hardware Kits / HKD1369



D1370-8480(SD)

Overall Length	216.2mm (8.51")	Overall Height	111mm (4.37")
----------------	-----------------	----------------	---------------

Backing Plate Design

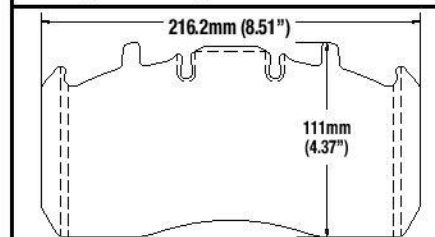

Friction Side

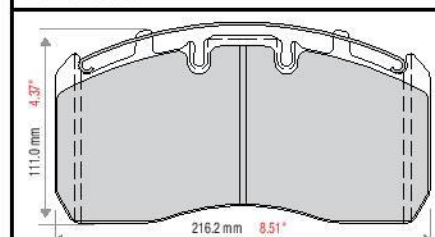

c/w Hardware Kits / HKD1311

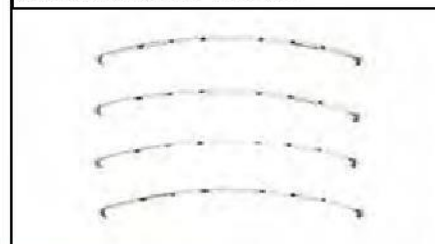

Air Disc Brake

D1407-8515

Overall Length	249.4mm (9.82")	Overall Height	118.1mm (4.65")
----------------	-----------------	----------------	-----------------

Backing Plate Design

Friction Side

c/w Hardware Kits / HKD1310-D1407

D1438-8556(SD)

Overall Length	210.3mm (8.28")	Overall Height	92.7mm (3.65")
----------------	-----------------	----------------	----------------

Backing Plate Design

Friction Side

c/w Hardware Kits / HKD1438

D1518-8727(SD)

Overall Length	175.5mm (6.91")	Overall Height	85.9mm (3.38")
----------------	-----------------	----------------	----------------

Backing Plate Design

Friction Side

c/w Hardware Kits / HKD1518

D1708-8931(SD)

Overall Length	249.7mm (9.83")	Overall Height	109.5mm (4.31")
----------------	-----------------	----------------	-----------------

Backing Plate Design

Friction Side

c/w Hardware Kits / HKD1311

D1777-9007(SD)

Overall Length	210.3mm (8.28")	Overall Height	109.7mm (4.32")
----------------	-----------------	----------------	-----------------

Backing Plate Design

Friction Side

c/w Hardware Kits / HKD1777

D2061-9294

Overall Length	210.3mm (8.28")	Overall Height	108.0mm (4.25")
----------------	-----------------	----------------	-----------------

Backing Plate Design

Friction Side

c/w Hardware Kits / HKD2061

Air Disc Brake



AIR DISC CALIPERS



**New or
Remanufactured
to OE
Specifications**

High Performance

**Wide Range of
Applications**

Air Disc Brake Caliper Identification Requires 7 Simple Steps

A. Identify adjustment design.



Pusher Plates
c/w caliper assembly



Two Tappets

B. Identify bridge style.



Flat



Pockets



Windows

C. Identify pad retainer style.

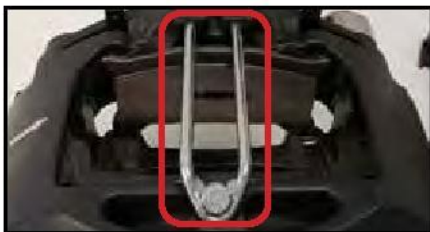

Rolled Bar



Flat plate stepped



Formed plate

D. Identify pad FMSI number.

E. Identify the location of caliper.

F. Refer to notes for more details.



Air
Disc
Brake



SilverbackHD also offers hardware kits for calipers.

			HKD1369-SN Shear nuts
			HKD1369-LP Large plug Dia. 1.13"
			HKD1369-SP Small plug Dia. 1.00"

A. Use chart to find the correct air disc caliper.

A	B	C	D	E	F	SilverbackHD Part #
Adjustment Design	Bridge Style	Pad Retainer Style	FMSI #	Location of Caliper	Notes	
Pusher Plate	Pocket	Rolled Bar	D1438	Left Side (Driver)	PAN19	40AC195037
Pusher Plate	Pocket	Rolled Bar	D1438	Right Side (Passenger)	PAN19	40AC195038
Pusher Plate	Pocket	Rolled Bar	D1518	Left Side (Driver)	PAN17	40AC175072
Pusher Plate	Pocket	Rolled Bar	D1518	Right Side (Passenger)	PAN17	40AC175073
Pusher Plate	Pocket	Rolled Bar	D1777	Left Side (Driver)	PAN22 Hendrickson & Meritor	64AC02250800
Pusher Plate	Pocket	Rolled Bar	D1777	Right Side (Passenger)	PAN22 Hendrickson & Meritor	64AC02250810
Pusher Plate	Pocket	Rolled Bar	D1777	Left Side (Driver)	PAN22 IMT, Reyco, Ridewell, SAF and AXN	40AC225015
Pusher Plate	Pocket	Rolled Bar	D1777	Right Side (Passenger)	PAN22 IMT, Reyco, Ridewell, SAF and AXN	40AC225016
Two tappets	Pocket	Formed plate	D1369	Left Side (Driver)	All trucks except Freightliner	10AC9962X
Two tappets	Pocket	Formed plate	D1369	Right Side (Passenger)	All trucks except Freightliner	10AC9961X
Two tappets	Pocket	Formed plate	D1369	Left Side (Driver)	Freightliner	10AX9958X
Two tappets	Pocket	Formed plate	D1369	Right Side (Passenger)	Freightliner	10AC9957X
Two tappets	Pocket	Formed plate	D1369	Left Side (Driver)	Trailer Hendrickson	11AC3888X
Two tappets	Pocket	Formed plate	D1369	Right Side (Passenger)	Trailer Hendrickson	11AC3887X
Two tappets	Pocket	Formed plate	D1369	Right Side (C88 axle, Left Side P89 axle)	Trailer SAF Holland	01AC2341X
Two tappets	Pocket	Formed plate	D1369	Right Side (P89 axle, Left Side C88 axle)	Trailer SAF Holland	01AC2342X
Two Tappets	Flat	Flat Plate stepped	D1311	Right Side (Passenger)	EX225H 201 Series	EXAC225H201X
Two Tappets	Flat	Flat Plate stepped	D1311	Left Side (Driver)	EX225H 202 Series	EXAC225H202X
Two Tappets	Pocket	Flat Plate stepped	D1311	Right Side (Passenger)	EX225H 301 Series	EXAC225H301X
Two Tappets	Pocket	Flat Plate stepped	D1311	Left Side (Driver)	EX225H 302 Series	EXAC225H302X
Two Tappets	Flat	Flat Plate stepped	D1370	Right Side (Passenger)	EX225L 201 Series	EXAC225L201X
Two Tappets	Flat	Flat Plate stepped	D1370	Left Side (Driver)	EX225L 202 Series	EXAC225L202X





AIR DISC ROTORS



**High Carbon
Cast Iron**

**GEOMET®
Rust Protection**

**Precision
Balanced**

Heavy Duty Air Disc Brake Rotor Identification Requires 8 Simple Steps

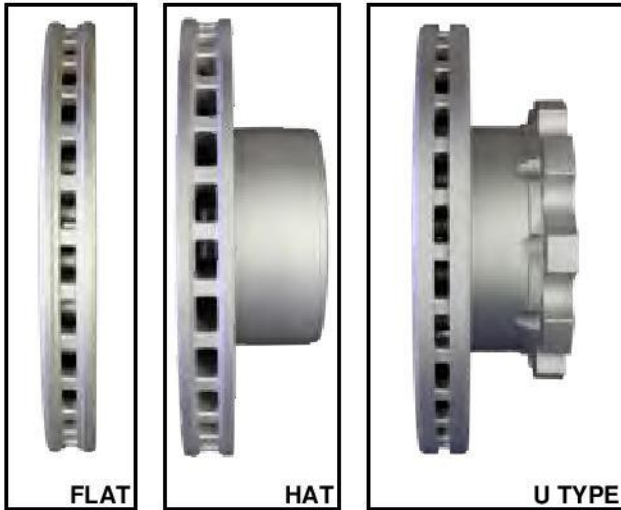

- A. Identify the style: Flat, Hat and U type.**
- B. Measure overall diameter.**
- C. Measure pilot diameter.**
- D. Measure bolt circle diameter from center of bolt holes.**
- E. Count bolt holes.**
- F. Measure overall depth.**
- G. Measure bolt hole size.**
- H. Measure thickness or see minimum thickness stamped or cast on rotor.**

Lastly, note whether it has any features such as ABS rings or splined mounting.

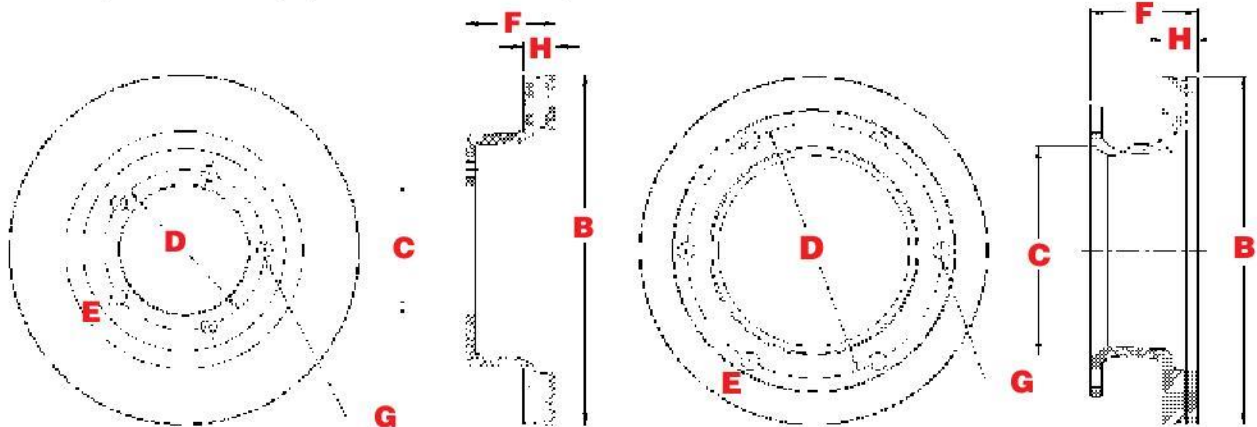

A	B	C	D	E	F	G	H	Special Info.	SilverbackHD Part #
Style	Overall Dia.	Pilot Dia.	Bolt Circle	Bolt Hole Qty.	Overall Depth	Bolt Hole Size.	Disc Thickness		
Flat	430.0mm (16.92")	217.0mm (8.54")	230.0mm (9.06")	N/A	45.0mm (1.77")	Splined	45.0mm (1.77")	c/w hardware	76AR692G
Hat	434.0mm (17.08")	135.3mm (5.32")	168.0mm (6.61") 178.0mm (7.00")	12 and 4	131.0mm (5.16")	18.9mm M16X2.0	45.0mm (1.77")		56AR641G
U	325.1mm (12.80")	173.0mm (6.81")	196.1mm (7.72")	8	148.6mm (5.85")	M14-2	34.0mm (1.34")	ABS cast teeth	75AR180G
U	376.9mm (14.85")	220.0mm (8.66")	249.4mm (9.82")	10	149.9mm (5.90")	M16-2	45.0mm (1.77")	ABS cast teeth	71AR601G
U	430.0mm (16.92")	220.0mm (8.65")	249.4mm (9.82")	10	138.0mm (5.44")	5/8"UNC	45.0mm (1.77")		76AR618G
U	430.0mm (16.92")	220.0mm (8.65")	249.4mm (9.82")	10	150.0mm (5.91")	5/8"UNC	45.0mm (1.77")		76AR617G
U	430.0mm (16.92")	220.0mm (8.65")	249.4mm (9.82")	10	150.0mm (5.90")	M16-2	45.0mm (1.77")	ABS cast teeth	76AR613G
U	430.0mm (16.92")	328.7mm (12.94") OD	285.8mm (11.25")	10	159.5mm (6.28")	M16X1.5mm R.H.	45.0mm (1.77")		10AR020109G
U	434.0mm (17.08")	194.0mm (7.64")	249.4mm (9.82")	10	143.5mm (5.65")	M16X2-6	45.0mm (1.77")		76AR606G
U	434.0mm (17.08")	215.9mm (8.50")	266.7mm (10.50")	10	143.5mm (5.65")	5/8-18UNF	45.0mm (1.77")		56AR642G



PARKING BRAKE SHOES



**2 New Shoes
c/w Springs**

**Short List
of SKUs**

**Maximum
Coverage**



Heavy Duty Emergency Brake Identification Requires 4 Simple Steps

A. Identify drum diameter.

B. Identify shoe width.



ALL SilverbackHD parking brake kits are two shoes with springs.

HKPB13032085KIT



HKPB1653KIT



HKPB2086KIT



C. Identify unique features.

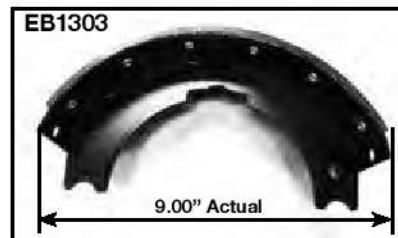

D. Use the table below to identify correct shoe required.

A	B	C	Application	FMSI	Replaces	SilverbackHD Part #
Drum Dia.	Shoe Width	Unique Features				
9.00"	3.00"	Shallow seat, shoe actual width 8.50"	GM, Dodge, Isuzu, IHC	S647-2086	597577C92 1798087 S-5829 2086PB	EB2086G
9.00"	3.00"	Deep seat, shoe actual width 8.50"	Ford	S646-2086	S-5828 2086PBH	EB2086
10.00"	3.00"	Shoe actual width 9.00"	IHC Truck and Bus	1303	A2-3722-G-501 A-3722-G-501 3722-E-499 3722-C-497 388912C91 S-A173 1303PB	EB1303
12.00"	3.00"	Adjuster cable guide and hold down pin on one shoe, shoe actual width 11.25"	IHC Truck and Bus, Ford, Freightliner, Workhorse	1653	2605826C91	EB1653
12.00"	4.00"	Shoe actual width 10.75"	Clark, Dana, Allison, Ford, IHC	2085	A3-3722-E-421 A-3722-E-421 3722-Y-415 3722-W-413 S-3502 2085PB	EB2085

Other



AIR SPRINGS



**10,000,000 Cycle
Tested**

Premium Quality

**Boxed c/w
Mounting
Fasteners**

Heavy Duty Air Spring Identification Requires 6 Simple Steps

Note: Record your information, it will help to correctly identify the correct air spring you require.

- A. Check the label, normally located on the top plate. If legible, please check the Cross Reference within the SilverbackHD website at <https://silverbackhd.com/>.**
- B. If the label is not legible you will first need to determine the style of air spring you require. Rolling Lobe Style, this style allows the rubber (bellows) to move up and down the piston surface to adjust the height. Convuluted Style, this style allows the rubber (bellows) to flex in and out, or Sleeve Style, this style is used for cabs and seats.**

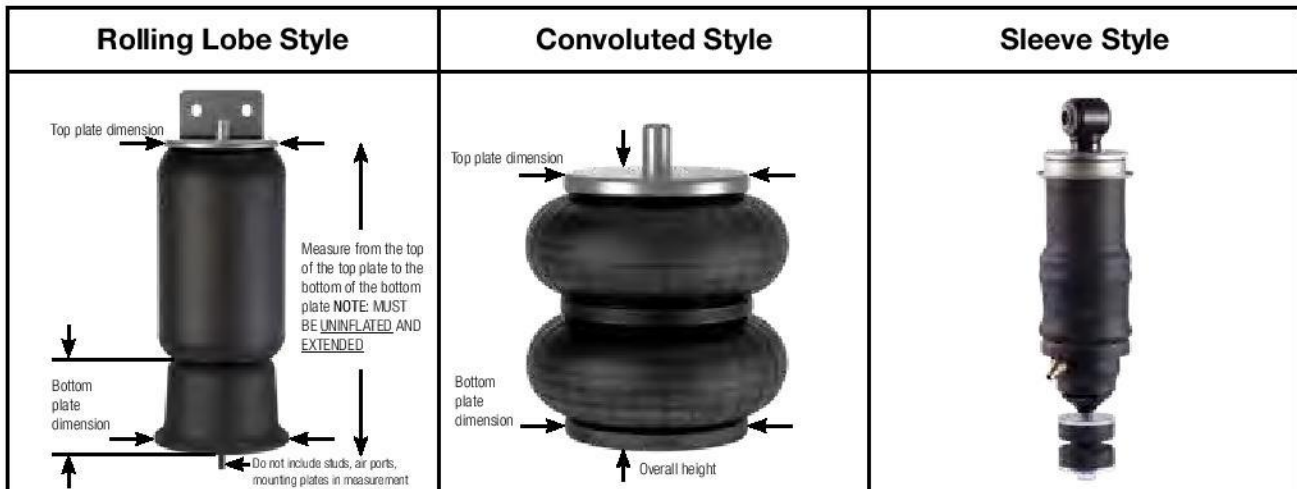

- C. Next, determine the air springs overall height's. This is the measurement from the top of the top plate to the bottom of the base. Note: Measure when uninflated and fully extended. Do not include items such as studs, air inserts plates mounted to the top plate into the overall height dimension.**
- D. Rolling Lobe style air springs start on page 54 and are sorted in order of height, from the shortest to the tallest. Using the drawings attached find the correct air springs with the same overall height. There may be several air springs with the same overall height. Now you will need to determine:**

- The width of the top plate
- The top plate bolt pattern, offset distance from center if applicable
- Quantity of bolts/air inserts on the top plate, thread pitch
- Width of the bottom plate
- Height of the bottom plate
- The bottom plate bolt/stud patterns, size, length, orientation of offset distance from center, if applicable and thread pitch. Use overall height, above A through F, to determine correct Rolling Lobe style air spring

- E. Convuluted style air springs are on page 65. Using the drawings attached find the correct air springs with the same overall height. Now you will need to determine:**

- The width of the top plate
- The top plate bolt pattern, offset distance from center if applicable



- *Quantity of bolts/air inserts on the top plate, thread pitch*
- *Width of the bottom plate*
- *Height of the bottom plate*
- *The bottom plate bolt/stud patterns, size, length, orientation of offset distance from center, if applicable and thread pitch. Use overall height, above A through F, to determine correct Convoluted style air spring*

F. Sleeve style air springs start on page 67 and are sorted in order of height, from the shortest to the tallest. Using the drawings attached find the correct air springs with the same overall height. There may be several air springs with the same overall height. Now you will need to determine:

- *The width of the top plate*
- *The top plate bolt pattern, offset distance from center if applicable*
- *Quantity of bolts/air inserts on the top plate, thread pitch*
- *Width of the bottom plate*
- *Height of the bottom plate*
- *The bottom plate bolt/stud patterns, size, length, orientation of offset distance from center, if applicable and thread pitch. Use overall height, above A through F, to determine correct Convoluted style air spring*

CAUTION: Firestone and Goodyear numbers molded into the rubber (bellows) are NOT the assembly numbers. Multiple air springs with the same number are used with various configurations of top plate and bottom plate sizes and configurations. Contact the SilverbackHD technical department for assistance. 1-855-848-8324.

SilverbackHD Air Spring Part #	Cross Section	Top Plate	Bottom Plate	Replaces
96AS22				AGA9622, ABPN32019622, AB1DK20G-9622, 65367, 352-9622, FS9622, W01-358-9622, 1R11-221, 1R11-280, K-303-22, AS9622, AS8537, AS96220, WA01-9622C
95AS47				AB1DK20G-9547, 68358, 452-9547, FS9547, W01-358-9547, AS9547, C81-1004, AS8859, AS95470, WA01-9547C
95AS41				AGA9541, AB1DK20H-9541, 66109, 452-9541, FS9542, W01-358-9541, AS9541, 1R11-268, C81-1005, AS8861, AS95410
90AS39				1R12-095, AB1DK23F-9039, 64260, 352-9039, FS9039, W01-358-9039, AS9039, S-11650, S-2064, 554766C1, 200457, 21208939, 21216135, 3130492, 12TA-1-2, 300-961250, 85101153, 1013589039C, AS90390, 90557011, 90557023, 90557085, 90044199, 90054234, TR9039, AS-8311, AS-0012, WA01-9039C
93AS07				1R12-435, AB1DK23F-9307, 64439, 452-9307, FS9307, W01-358-9307, AS9307, 17360-01, 90557129, TR9307, AS-8471, AS93070, WA01-9307C



SilverbackHD Air Spring Part #	Cross Section	Top Plate	Bottom Plate	Replaces
87AS29				AGA8729, AB1DK25D-8729, 77963, 352-8729, FS8729, W01-358-8729, FLTA1R13130, 1R13-130, 1R13-261, AS8729, AS8513, AS87290, WA01-8729C
98AS07				AGA9807, AB1DK23I-9807, 68151, 352-9807, FS9807, W01-358-9807, 1R12-1047, AS9807, 50857000, 90557372, AS8874, AS98070, WA01-9807C
96AS16				AB1DK23P-9616, 64256, 352-9616, FS9616, W01-358-9616, 1R11-242, K-303-16, AS9616, AS8515, AS96160,
82AS04				AGA8204, AB1DK23H-8204, 64456, 352-8204, FS8204, W01-358-8204, FLTA1R12508, 1R12-508, 1R12-1078, AS8204, 90557173, 90557223, XDSPN05360, AS8484, AS82040, WA01-8204C
94AS22				AGA9422, ABPN32019422, AB1DK20D-9422, 64255, 352-9422, FS9422, W01-358-9422, FLTA1R11028, 1R11-028, 1R11-279, S-13032, K-303-14, K-303-6, K-305-15, 554762C1, 1003589422C, AS9422, 57009422, AS8314, AS94220, 85101148, AS-0017, WA01-9422C

SilverbackHD Air Spring Part #	Cross Section	Top Plate	Bottom Plate	Replaces
92AS70				AGA9270, ABPN32019270, AB1DK23I-9270, 64287, 352-9270, FS9270, W01-358-9270, FLTA1R13119, 1R13-119, 1R13-259, C-20010, C-20559, C-21208, S-20010, S20559, S-21208, 1003589270C, AS9270, AS8433, AS92700, 85101147, AS-0084, WA01-9270C
88AS06				1R12-445, ABIDK23I-8806, 64486, FS8806, W01-358-8806, AS8806, 1003588806C, AS-8545, AS88060, AS-0183
87AS82				AB1DK258-8782, 66340, 452-8782, FS8782, W01-358-8782, 1R13-109, 1001R13109G, AS8871, AS87820
90AS69				AGA9069, ABPN32019069, AB1DK23I-9069, 64274, 352-9069, FS9069, W01-358-9069, FLTA1R12069, 1R12-069, 1R12-669, 1R12-1069, S-133031, 554764C1, 03-01649, 03-02038, 03-02456, 03-04759, 03-06746, 03-07112, 03-10042, 1003589069C, AS9069, 57009069, AS8312, AS90690, 85101145, C81-6022, AS-0077, WA01-9069C
80AS91				AGA8091, AB1DK28E-8091, 64421, 352-8091, FS8091, W01-358-8091, FLTA1R14171, 1R14-093, 1R14-171, 1R14-245, C-0901, S-20901, S-21784, AS8091, AS8523, AS80910, WA01-8091C





SilverbackHD Air Spring Part #	Cross Section	Top Plate	Bottom Plate	Replaces
85AS39				1R13-188, AB1DK25F-P1219, 78239, 452-8539, FS8539, W01-358-8539, AS8539, S-29892, SR1VA101-1, SR1JA100, AR1VA105, TR8539, AS-81219, AS85390
80AS50				AGA8050, ABPN32018050, AB1DK28A-8050, 64254, 352-8050, FS8050, W01-358-8050, FLTA1R14039, 1R14-0383, 1R14-039, 1R14-055, 1R14-244, 36514-13, B-12514-013, B-4771, S-4771, 1685174C1, AS8050, 57008050, AS8320, AS80500, 3130498, AS-0039, WA01-8050C
99AS78				AB1DK23I-A959, 57588, 352-9978, FS9978, W01-358-9978, S-28929, AS9978, AS8959, AS99780
87AS09				AGA8709, ABPN32018709, AB1DK25A-8709, 64645, 352-8709, FS8709, W01-358-8709, FLTA1R13159, 1R13-159, 1R13-262, C-20900, C-21800, S-20900, S-21800, AS8709, AS8460, AS87090, WA01-8709C
87AS55				AGA8755, AB1DK25B-8755, 64397, 352-8755, FS8755, W01-358-8755, FLTA1R13124, 1R13-124, 1R13-260, C-21623, C-22045, S-21623, S-22045, AS8755, AS8522, AS87550, WA01-8755C

Air Springs

SilverbackHD Air Spring Part #	Cross Section	Top Plate	Bottom Plate	Replaces
88AS29				AB21DK23K-8829, 3528829, 352-8829, FS8829, W01-358-8829, FLTA1R12615, 1R12-615, 1R12-1083, AS8829, AS8449, AS88290, 3934699, 8079902, 8084296, 8097092, 20396293, 20413888, 20505399, 57QL54M, WA01-8829C
92AS13				1R12-090, AB1DK23K-9213, 64308, 352-9213, FS9213, W01-358-9213, AS9213, S-13033, 1686386C1, 501559C1, 1660581C1, 501559C2, 3130495, 1003589213C, AS92130, TR9213, AS-8441, WA01-9213C
96AS48				AGA9648, AB1DK23M-9648, 64263, 352-9648, FS9648, W01-358-9648, FLTA1R12538, 1R12-538, 1R12-1080, 2027911C1, 2027911C2, 2027911C3, AS9648, AS8456, AS96480, WA01-9648C
96AS26				1R11--292, AB1DK20J-9626, 64692, 452-9626, FS9626, W01-358-9626, AS9626, S-23720, TR9626, AS-8568, AS96260
90AS26				1R12-567, AB1DK23K-9026, 64306, 452-9036, FS9026, W01-358-9026, AS9026, 03-06213, AS90260, TR9026, AS-8393, AS90260, WA01-9026C



SilverbackHD Air Spring Part #	Cross Section	Top Plate	Bottom Plate	Replaces
90AS82				AGA9082, AB1DK23K-9082, 64269, 352-9082, FS9082, W01-358-9082, FLTA1R12092, 1R12-092, 1R12-1070, 36514-7, B-12514-007, S-11651, S-13159, S-2066, S-4041, 57QL310, 517559C9, 12882-01, 1003589082C, AS9082, 90044200, 90044647, 90557027, 90557033, 90557037, 90557054, 90557075, AS8310, AS90820, 3130491, AS-0011, WA01-9082C
87AS74				AB1DK28M-8774, 65593, 352-8774, FS8774, W01-358-8774, 1R14-172, S-25873, AS-0159, AS87740, WA01-358-8774, AS8774
96AS44				AB1DK23J-9644, 64693, 452-9644, FS9644, S-23721, TR9644, AS-8569, AS96440
84AS63				1R12-647, AB1D23H-P1153, 74883, FS8463, W01-M58-8463, AS8463, 20733034, 57QL519M, AS84630, AS-81153, AS11533
84AS68				1R12-654, 1R12-1049, AB1D23H-P1206, 75561, FS8468, W01-M58-8468, AS8468, 21132004, 21132005, 21244322, 21669088, TR8468, AS-81206, AS84680



SilverbackHD Air Spring Part #	Cross Section	Top Plate	Bottom Plate	Replaces
87AS08		 ③3/4"-16UNF; 1/4"-18NPT	 ● 1/2"-13UNC	AB1DK25E-8708, 64638, 4528708, 452-8708, FS8708, W01-358-8708, FLTA1R13177, 1R13-177, 1R13-264, S-21966, AS8708, AS8526, AS87080, WA01-8708C
87AS13		 ③3/4"-16UNF; 1/4"-18NPT	 ● 1/2"-13UNC	AB1DK25E-8713, 64636, 352-8713, FS8713, W01-358-8713, FLTA1R13176, 1R13-140, 1R13-176, 1R13-263, C-22948, S-22948, AS8713, AS8533, AS87130, WA01-8713C
93AS71		 ③3/4"-16UNF; 1/4"-18NPT ● 1/2"-13UNC	 ● 1/2"-13UNC	AB1DK23P-9371, 64290, 352-9371, FS9371, W01-358-9371, 1R12-401, 1R12-1074, CS112401, 1670043C1, 1670073C1, 1686386C1, AS9371, AS8521, AS93710, AS-0139, WA01-9371C
99AS21		 ③3/4"-16UNF; 1/4"-18NPT ● 1/2"-13UNC	 ● 1/2"-13UNC	AB1DK23P-9921, 64402, 352-9921, FS9921, W01-358-9921, 1R12-502, AS9921, 90557117, AS8443, AS99210, AS-0090, WA01-9921C
99AS36		 ③3/4"-16UNF; 1/4"-18NPT ● .500 PIN	 ● 1/2"-13UNC	1R12-499, AB1DK23P-9936, 64405, 452-9936, FS9936, W01-358-9936, AS9936, 90557156, 90557300, TR9936, AS8454, AS99360



SilverbackHD Air Spring Part #	Cross Section	Top Plate	Bottom Plate	Replaces
93AS73				AGA9373, AB1DK23M-9373, 64265, 64336, 352-9373, FS9373, W01-358-9373, FLTA1R12403, 1R12-403, 57122-1, 57122-2, 2992101C1, AS9373, AS8519, AS93730, AS-0141, AS-0217G, WA01-9373C
93AS75				AB1DK23P-9375, 64264, 352-9375, FS9375, W01-358-9375, 1R12-404, 1R12-1076, 50899-1, 50899-2, 364SQ27, 57QL414M, AS9375, AS8451, AS93750, WA01-9375C
99AS74				ABPN32019974, AB1DK23P-9974, 67586, 352-9974, FS9974, W01-358-9974, 1R12-1048, AS9974, 90557332, AS8930, AS99740
91AS21				1R13-039, AB1D28G-9121, 64272, 352-9121, W01-358-9121, FS9121, AS9121, S-13160, 554773C1, 85101159, 3130503, 12882-02, 6424, 1003589121C, 90557019, 90557010, 90557052, 90557078, 90557083, 90557110, 90557324, 90044702, 90054060, TR9121, AS-8317, AS91210, AS-0013
99AS35				AB1DK23P-9935, 64412, 352-9935, FS9935, W01-358-9935, 1R12-532, AS9935, 90557157, 90557301, AS8548, AS99350, AS-0164-1G, WA01-9935C

SilverbackHD Air Spring Part #	Cross Section	Top Plate	Bottom Plate	Replaces
97AS80				AGA9780, AGA9781, ABPN32018537, ABPN32019781, AB1DF23-9780, AB1DF23-9781, 64266, 67473, 352-9780, 352-9781, FS9780, FS9781, W01-358-9780, W01-358-9781, AS9780, AS9781, FLTA1R12303, FLTA1R12603, 16-13810-000, 16-13810-001, 16-13810-002, 16-13840-000, 16-14004-000, 16-14004-001, 16-14377-000, 16-15595-000, 16-15595-000, 16-15595-001, 16-16773-000, 16-16825-000, 16-19465-000, 16-19466-000, 16-19467-000, 16-19468-000, 681-320-0017, A16-13668-002, A16-14004-000, 1R12-1082, 1R12-1072, 1R12-303, 1R12-603, 10089780C, AS8382, AS-8382P, AS8999, AS97800, AS97810, 85101151, AS-0147-1G, AS-0182, WA01-9780C, WA01-9781C
92AS43				AB1DK23L-9243, 64329, 452-9243, FS9243, W01-358-9243, AS9243, 90557112, TR9243, AS-8384, AS-0061
11AS90				AB1DK23R-9876, 73745, 352-1190, FS1190, W01-358-1190, 1R12-523, 3541732C1, 2514461C1, AS11901, AS1190
11AS91				AB1DK23R-1731, 73746, 452-1191, AS1191, 1R12-1077, 1R12-432, 350243C94, 3541731C1, AS11910
11AS92				AB1DF231-P1137, 74662, 352-1192, FS1192, W01-358-1192, 1R12-689, 3691773C1, AS11920, AS1192



SilverbackHD Air Spring Part #	Cross Section	Top Plate	Bottom Plate	Replaces
88AS52				AB1DK23L-8852, 64339, 352-8852, FS8852, W01-358-8852, FLTA1R12568, 1R12-568, 1R12-1081, 03-07887, AS8852, AS8472, AS88520, WA01-8852C
95AS80				AGA9580, AB1DK25C-9580, 64349, 352-9580, FS9580, W01-358-9580, FLTA1R13118, 1R13-081, 1R13-118, 1R13-258, C-20127, C-20414, S-20127, S-20414, AS9580, AS8434, AS95800, WA01-9580C
88AS64				AB1DK23L-8864, 66666, 352-8864, FS8864, W01-358-8864, 1R12-1097, C81-1011, FC81-1013, 03-08716, AS8864, AS8898, AS88640, WA01-8864C
94AS71				1R12-504, AB1DK23P-9471, 69648, 452-9471, FS9471, W01-358-9471, AS9471, 90557146, 90557177, 90557182, 90557212, TR9471, AS-8052, AS94710
92AS65				AGA9265, ABPN32019265, AB1DK23L-9265, 64288, 352-9265, FS9265, W01-358-9265, FLTA1R12375, 1R12-375, 1R12-1073, C-20124, C20413, S-20124, S-20413, AS9265, AS8435, AS92650, 85181155, WA01-9265C

SILVERBACK^{HD}

SilverbackHD Air Spring Part #	Cross Section	Top Plate	Bottom Plate	Replaces
91AS01				AB1DK23L-9101, 64279, 352-9101, FS9101, W01-358-9101, AS9101, 1R12-103, S-10443, 554768C1, 12883-01, 1003589101C, S5828C, S740C, 90044201, 90044701, 90054218, 90557008, 90557009, 90557043, 90557082, AS8315, AS91010, 3130490, 85101149, AS-0040, WA019101C
93AS94				AB1 DK23L-9394, 64237, 64615, 352-9394, FS9394, W01-358-9394, UCD-9392-2, UCE-9393-3, 1R12-281, S-10352, 1003589394C, AS9394, AS8321, AS93940, AS-0142, WA01-9394C
91AS22				AGA9122, AB1D28C-9122, 64273, 352-9122, FS9122, W01-358-9122, FLTA1R13038, 1R13-038, 1R14-045, 1R13-257, 36510-4, 36514-2, 36514-8, C-22173, S-12514-008, S-3830, 554772C1, S3053C, AS9122, 90554043, 90557071, 90557076, 90557077, AR12151G, AS8313, AS8530, AS91220, 3130500, WA01-9122C
96AS19				AB1DK20K-9619, 64697, FS9619, W01-358-9619, AS9619, S-23614, AS-8741, AS96190,
93AS21				AB1DK23N-9321, 64384, 64716, 352-9321, FS9321, W01-358-9321, 1R12-256, 1R12-335, 1R12-1071, B-14259, NS501304, 1003589321C, AS9321, 57009321, AS8505, AS8505P, AS93210, 85101160, AS-0036, WA01-9321C



SilverbackHD Air Spring Part #	Cross Section	Top Plate	Bottom Plate	Replaces
93AS70				AB1DK23N-9370, 64383, 352-9370, FS9370, W01-358-9370, 1R12-440, 1003589370C, AS9370, AS-8448, AS93700, AS-0057, WA01-9370C
76AS59				2B7-548, SP2B07RA-7659, 67667, FS7659, W01-358-7659, AS7659, 005709, TR7659, AS-4775, AS76590
77AS05				SP2B08RA-7705, 64666, 454-7705, FS7705, W01-358-7705, AS7705, AS-4715, AS77050, AS-0068
68AS97				SP2B12R-6897, 64517, 354-6897, FS6897, W01-358-6897, 2B9-229, 2B9-494, 1002486897C, AS6897, AS4505, AS4706, AS68970, AS-0058, WA01-6897C
69AS02				SP2B12R-6902, 64509, 354-6902, FS6902, W01-358-6902, 2B9-493, 2B9-201, S-2630, 554784C1, 1003586902C, AS6902, 57006902, AS4499, AS69020, AS-0002, WA01-6902C

SilverbackHD Air Spring Part #	Cross Section	Top Plate	Bottom Plate	Replaces
69AS05				2B9-206, SP2B12R-6905, 64510, 354-6905, FS6905, W01-358-6905, AS6905, S-3518, S-5270, 45843-1, 1685175C1, 85101146, 6389, 1003586905C, AS69050, 57006905, TR6905, AS4315, AS69050, AS-0020, WA01-6905C
69AS10				2B9-200, SP2B12R-6910, 64267, 354-6910, FS6910, W01-358-6910, AS6910, S-8768, 45843-3, 554784C1, 2726, 1371, 1003586910C, AS6910, 57006910, TR6910, AS-4320, AS69100, AS-0001, WA01-6910C
77AS95				2B10-226, SP2B12R-7795, 67705, 454-7795, AS7795, W01-358-7795, B-14486, 003317, S-14486, AS77950, TR7795, AS-4713, AS77950, AS-0146-1G, WA01-7795C
78AS97				2B9-495, 64683, 454-7897, FS7897, w01-358-7897, W01-455-7898, W01-455-8148, AS7897, 002878, S-23114, TR7897, AS4709, AS78970,
71AS80				2B12-425, SP2B22R-7180, 64493, 454-7180, 64493, FS7180, W01-358-7180, AS7180, 1685179C1, 1003587180C, 57007180, AS-4363, AS71800





SilverbackHD Air Spring Part #	Cross Section	Top Plate	Bottom Plate	Replaces
80AS32		 ⊙ 3/4" - 16UNF; 1/4" - 18NPT ● 3/8" - 16UNC	 ● 3/8" - 16UNC	3B12-319, SP3B22R-8032, 64560, 454-8032, FS8032, W01-358-8032, AS8032, S-12405, 1003588032C, AS80320, TR8032, AS-4413, AS80320
80AS33		 ⊙ 3/4" - 16UNF; 1/4" - 18NPT ● 1/2" - 13UNC	 ● 3/8" - 16UNC	3B12-312, SP3B22R-8033, 64571, 454-8033, FS8033, W01-358-8033, AS8033, 003316, B-14487, S-14487, AS8033, TR8033, AS-4525, AS80330, AS-0168G, WA01-8033C
72AS06	 PLUMB TO CONNECT AIR FITTING	 Recommended mounting hole 0.72" diameter	 1/4" Air tube fitting Rec. mounting hole 1.34" dia.	1S5-176
70AS01		 ● 3/8" - 16UNC	 3/4" - 16UNF-2A outside 1/8" - 27NPTF inside	ABSZ70-7001, 67770, FS7001, W01-358-7001, 227QS33, 2501293C1, AS7001, AS-5001, AS70010
70AS87		 1/2" O.D. smooth	 3/4" smooth outside 1/8" - 27NPTF inside	ABSZ70-7087, 67636, 453-7087, FS7087, W02-358-7087, GYR1S5-040, 1S5-040, AS7087, AS5087, AS70870

Air Springs

SilverbackHD Air Spring Part #	Cross Section	Top Plate	Bottom Plate	Replaces
70AS64				ABSZ70-7064, 67768, 453-7064, FS7064, W02-358-7064, 1S5-157, AS7064, AS-5064, AS70640, WA01-7064C
71AS09				ABSZ70-7109, 69624, FS7109, W02-358-7109, T811000, AS7109, AS71090
72AS05				ABPN32027205, ABSZ70-7205, 67638, 453-7205, FS7205, W02-358-7205, AS7205, AS-5205, AS72050, 6600-3406
70AS59				ABSZ70-7059, 353-7059, FS7059, W02-358-7059, AS7059, AS70590
72AS15				ABPN32027215, ABSZ70-7215, 68161, 453-7215, FS7215, W02-358-7215, 18-40977-000, 18-52651-000, 18-66715-000, 1S5-175, AS7215, AS72150, WA01-7215C



SilverbackHD Air Spring Part #	Cross Section	Top Plate	Bottom Plate	Replaces
70AS93		<p>3.09 Recommended mounting hole 0.72" diameter</p>	<p>2.87 1/4" Air tube fitting Rec. mounting hole 1.34" dia.</p>	ABSZ70-7093, 64526, 453-7093, FS7093, W01-358-7093, AS7093, AS-4515, AS70930
70AS36		<p>2.90 3/8"-16UNC</p>	<p>2.11 3/4"-16UNF-2A outside 1/8"-27NPTF inside</p>	ABPN32027036, ASBZ70-7036, 68162, 453-7036, FS7036, W02-358-7036, 1S5-186, 29-02454, 29-03200, AS7036, AS-5036, AS70360, WA01-7036C
60AS58		<p>3.11 M10x1.50</p>	<p>4.02 1/8"-27NPTF</p>	1S6-058, ABSZ70-2624, 21165209, 20462624, 20463622, 57912005000000, 57912005800035, TR6058
51AS71		<p>3.11 M10x1.50</p>	<p>2.17 1/8"-27NPTF</p>	1S5-171, ABSZ70-2622, 78421, 21165207, 20462622, 80746292, 579100065, 57910014100000, 57910017100035, 1S5-065, 1S5-141, TR5171
70AS81		<p>2.89 3/4" smooth outside 1/8"-27NPTF inside</p>	<p>2.12 3/8"-16UNC</p>	ABSZ70-7081, 453-7081, FS7081, W02-358-7081, 1S5038, 1S5-038, 2501300C1, AS7081, AS70810

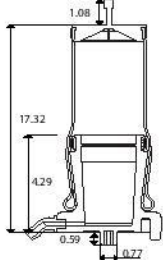
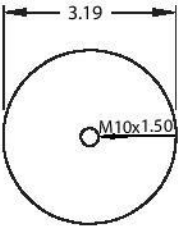
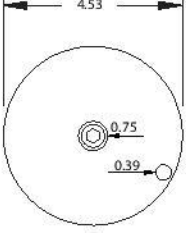

SilverbackHD Air Spring Part #	Cross Section	Top Plate	Bottom Plate	Replaces
60AS54				1S6-054, ABSZ70-2453, 21338453, 21193602, TR8451





Numerical Parts Listing

Part Number	Page	Part Number	Page	Part Number	Page	Part Number	Page	Part Number	Page
01AC2341X	45,46	2424PBK	32	36BD87B	13	55CL250	35, 37	76AR613G	48
01AC2342X	45,46	2424SB	32	36BD99B	12	55CL251	35, 37	76AR617G	48
09CL	33	2430PBK	32	37BD10B	12	55CL252	35, 37	76AR618G	48
09D	33	2430SB	32	37BD21AB	12	55CL314	35, 37	76AR692G	48
09SC	32	24CL	33	37BD44B	12	55CL849	35, 37	76AS59	65
10AC9957X	45,46	24D	33	37BD53B	12	55CL850	35, 37	77AS05	65
10AC9958X	45,46	24SC	32	37BD57B	13	56AR641G	48	77AS95	66
10AC9961X	45,46	25BD46CB	13	37BD58B	12	56AR642G	48	78AS97	66
10AC9962X	45,46	27BD05B	13	37BD60BB	12	5850CV	33	80AS32	67
10AR020109G	48	29BD83CB	13	37BD74B	12	5858CV	33	80AS33	67
11AC3887X	45,46	29BD97DB	13	37BD82B	13	58CP	33	80AS50	57
11AC3888X	45,46	3030PBK	32	37BD96B	13	60AS54	70	80AS91	56
11AS90	62	3030PBKLS	32	38BD00B	12	60AS58	69	82AS04	55
11AS91	62	3030RB	33	38BD07AB	13	61HR78AMG	39	84AS63	59
11AS92	62	3030SB	32	38BD87B	12	64AC02250800	45,46	84AS68	59
12CL	33	3030SB-INT	32	38BD89B	13	64AC02250810	45,46	85AS39	57
12D	33	3030SBLs	32	40AC175072	45,46	68AS97	65	86BD56B	13
12SC	32	3030SBLs-INT	32	40AC175073	45,46	69AS02	65	87AS08	60
13CL706-7	35, 37	30BD18AB	13	40AC195037	45,46	69AS05	66	87AS09	57
14CL684012-3	35, 37	30BD22BB	13	40AC195038	45,46	69AS10	66	87AS13	60
14CL684014-5	35, 37	30CLW	33	40AC225015	45,46	70AS01	67	87AS29	55
14CL7076	35, 37	30D	33	40AC225016	45,46	70AS36	69	87AS55	57
14CL7077	35, 37	30SC	32	5050CV	33	70AS59	68	87AS74	59
14HR1394G	39	31BD20B	13	50CP	33	70AS64	68	87AS82	56
16CL	33	31BD41B	13	51AS71	69	70AS81	69	88AS06	56
16D	33	31BD41BB	13	54HR102G	39	70AS87	67	88AS29	58
16SC	32	31BD58B	12	54HR104G	39	70AS93	69	88AS52	63
1824ADSB	32	31BD66B	12	54HR105G	39	71AR601G	48	88AS64	63
18ADSC	32	31BD74B	12	54HR301G	39	71AS09	68	90AS26	58
19HR996G	39	32BD95AB	13	54HR365G	39	71AS80	66	90AS39	54
2024ADSB	32	34BD02B	13	54HR769G	39	72AS05	68	90AS69	56
20ADSC	32	34BD67BB	12	54HR770G	39	72AS06	67	90AS82	59
20CL	33	35BD57B	12	54HR771G	39	72AS15	68	91AS01	64
20D	33	35BD76B	13	54HR773G	39	75AR180G	48	91AS21	61
20SC	32	36BD00AB	13	54HR775G	39	76AR606G	48	91AS22	64



Part Number	Page	Part Number	Page	Part Number	Page	Part Number	Page	Part Number	Page
92AS13	58	ASG1136	28	ASM801102	28	CS1147CR	16, 21	CS4893L	16, 21
92AS43	62	ASG1138	28	ASM802446	28	CS1148CL	16, 21	CS5003L	16, 21
92AS65	63	ASG1140	28	ASM802447	28	CS11528R	16, 21	CS5004R	16, 21
92AS70	56	ASG1141	28	ASM802486	28	CS11529L	16, 21	CS5492L	16, 21
93AS07	54	ASG1142	28	ASM802487	28	CS11860L	19, 21	CS5493R	16, 21
93AS21	64	ASG1144	28	CRK10897B	21, 24	CS11861R	19, 21	CS5496L	19, 21
93AS70	65	ASG1146	28	CRK11450B	24	CS11864L	16, 21	CS5497R	19, 21
93AS71	60	ASG1147	28	CRK11897B	21, 24	CS11865R	16, 21	CS5506L	17, 21
93AS73	61	ASG1150	28	CRK11910B	21, 24	CS11866L	16, 21	CS5507R	17, 21
93AS75	61	ASH40010001	28	CRK2086BB	22	CS11867R	16, 21	CS5508L	17, 21
93AS94	64	ASH40010008	28	CRK2087B	22	CS1410R	18, 21	CS5509R	18, 21
94AS22	55	ASH40010013	28	CRK2088AB	21,22	CS1411L	18, 21	CS5510L	19, 21
94AS71	63	ASH40010070	28	CRK2089B	21,22	CS1422R	18, 21	CS5511R	19, 21
95AS41	54	ASH40010140	28	CRK2090B	21,22	CS1423L	18, 21	CS5520L	18, 21
95AS47	54	ASH40010141	28	CRK2122B	21,22	CS1424AR	18, 21	CS5521R	18, 21
95AS80	63	ASH40010142	28	CRK2125B	22	CS1425AL	18, 21	CS5524L	18, 21
96AS16	55	ASH40010143	28	CRK2287B	21,22	CS1563L	17, 21	CS5525R	18, 21
96AS19	64	ASH40010144	28	CRK2469B	21,22	CS1564R	17, 21	CS5526L	19, 21
96AS22	54	ASH40010145	28	CRK2494B	21, 23	CS1775R	16, 21	CS5527R	19, 21
96AS26	58	ASH40010155	28	CRK2680B	23	CS1776L	16, 21	CS684R	18, 21
96AS44	59	ASH40010156	28	CRK2696AB	21,23	CS2099L	18, 21	CS685L	18, 21
96AS48	58	ASH40010211	28	CRK3520AB	21, 23	CS2100R	18, 21	CS7217L	19, 21
97AS80	62	ASH40010212	28	CRK3993BB	21, 23	CS2492R	18, 21	CS7218R	19, 21
98AS07	55	ASH40010213	28	CRK5094AB	23	CS2493L	18, 21	CS9059L	19, 21
99AS21	60	ASH40010214	28	CRK5307B	23	CS3854L	17, 21	CS9060R	19, 21
99AS35	61	ASH40010215	28	CRK5501B	23	CS3855R	17, 21	CS9100L	19, 21
99AS36	60	ASH40010216	28	CRK9078B	21, 23	CS3856L	18, 21	CS9101R	19, 21
99AS74	61	ASH40010305	28	CRK9079B	21, 24	CS3857R	18, 21	CS9649L	16, 21
99AS78	57	ASH40010306	28	CRK9080B	24	CS3861L	19, 21	CS9650R	16, 21
APPL	33	ASH40020211	28	CRK9790AB	21, 24	CS3862R	19, 21	CS9655L	16, 21
ASB65175	28	ASH40020212	28	CRK9791B	24	CS4716R	19, 21	CS9656R	16, 21
ASB65179	28	ASH40020231	28	CS10905L	18, 21	CS4717L	19, 21	CS9657L	16, 21
ASB65247	28	ASM801041	28	CS10906R	18, 21	CS4720R	19, 21	CS9658R	16, 21
ASB65344	28	ASM801042	28	CS10907L	19, 21	CS4721L	19, 21	CS9659L	16, 21
ASB65700	28	ASM801073	28	CS10908R	19, 21	CS4884L	18, 21	CS9660R	16, 21
ASG1132	28	ASM801074	28	CS10909L	19, 21	CS4885R	18, 21	CS9661L	16, 21
ASG1133	28	ASM801079	28	CS10910R	19, 21	CS4892R	16, 21	CS9662R	16, 21



Part Number	Page	Part Number	Page	Part Number	Page	Part Number	Page	Part Number	Page
CS9663L	17, 21	D1438-8556	41,43	HK1225Q	5, 9, 10	WK1443E-23KSB	4	WK4707QR-23KSB	5
CS9664R	17, 21	D1438-8556SD	41,43	HK1225SF	5, 9, 10	WK4311E-20KSB	4	WK4709ES2-20KSB	4
CS9665L	17, 21	D1518-8727	41,43	HK1308E	4, 9, 10	WK4311E-23KSB	4	WK4709ES2-23KSB	4
CS9666R	17, 21	D1518-8727SD	41,43	HK1308Q	4, 9, 10	WK4514Q-20KSB	4	WK4709ES2-23KSBHTP	4
CS9669L	17, 21	D1708-8931	41,43	HK1657QM	4, 9, 10	WK4514Q-23KSB	4	WK4709ES2F-23KSB	5
CS9670R	17, 21	D1708-8931SD	41,43	HK4311E	4, 9, 10	WK4514QR-20KSB	4	WK4710Q-20KSB	5
CS9671L	17, 21	D1777-9007	41,43	HK4515F-3	5, 9, 10	WK4514QR-23KSB	4	WK4710Q-23KSB	5
CS9672R	17, 21	D1777-9007SD	41,43	HK4515Q-34	4, 5, 9, 10	WK4515Q-20KSB	5	WK4710Q-23KSBHTP	5
CS9673AL	17, 21	D184-7806CE	35,37	HK4702Q	4, 5, 9, 10	WK4515Q-23KSB	5	WK4711Q-20KSB	5
CS9674AR	17, 21	D184-7806SD	35,37	HK4709E-12	4, 5, 9, 10	WK4515Q-23KSBHTP	5	WK4711Q-23KSB	5
CS9675L	17, 21	D2061-9294	41,43	HK4719E	4, 5, 9, 10	WK4515XEM3-20KSB	5	WK4711Q-23KSBHTP	5
CS9676R	17, 21	D224-7807CE	35,37	HK4729E	4, 9, 10	WK4515XEM3-23KSB	5	WK4715Q-20KSB	4
CS9677L	17, 21	D224-7807SD	35,37	HK802TB119	46	WK4524Q-20KSB	4	WK4715Q-23KSB	4
CS9678R	17, 21	D225-7808CE	35,37	HK803GP114	46	WK4524Q-23KSB	4	WK4718Q-20KSB	5
CS9681L	17, 21	D225-7808SD	35,37	HKD1203	42	WK4524QR-20KSB	4	WK4718Q-23KSB	5
CS9682R	17, 21	D236-7809CE	35,37	HKD1310-D1407	42, 43	WK4524QR-23KSB	4	WK4718Q-23KSBHTP	5
CS9683L	17, 21	D769-7636CE	35,37	HKD1311	42, 43	WK4551Q-20KSB	5	WK4719ES2-20KSB	4
CS9684R	17, 21	D769-7636SD	35,37	HKD1312	42	WK4551Q-23KSB	5	WK4719ES2-23KSB	4
CS9731L	17, 21	D786-7655CE-THICK	35,37	HKD1369	42	WK4591DX-20KSB	5	WK4720Q-20KSB	4
CS9732R	17, 21	D786-7655SD-THICK	35,37	HKD1369-LP	46	WK4591DX-23KSB	5	WK4720Q-23KSB	4
CS9733L	18, 21	D786A-7654CE-THIN	35,37	HKD1369-SN	46	WK4591SF-20KSB	5	WK4725ES2-20KSB	4
CS9734R	18, 21	D786A-7654SD-THIN	35,37	HKD1369-SP	46	WK4591SF-23KSB	5	WK4725ES2-23KSB	4
CS9735L	19, 21	EB1303	50	HKD1438	43	WK4670Q-20KSB	5	WK4726ES2-20KSB	5
CS9736R	19, 21	EB1653	50	HKD1518	43	WK4670Q-23KSB	5	WK4726ES2-23KSB	5
D1066-7972CE	35,37	EB2085	50	HKD1777	43	WK4692Q-20KSB	5	WK4726ES2-23KSBHTP	5
D1066-7972SD	35,37	EB2086	50	HKD2061	43	WK4692Q-23KSB	5	WK4726ES2-23KSBHTP	5
D1203-8323	41, 42	EB2086G	50	MS44064	29	WK4702Q-20KSB	4	WK4729ES-20KSB	4
D1203-8323SD	41, 42	EXAC225H201X	46	MS44071	29	WK4702Q-23KSB	4	WK4729ES-23KSB	4
D1310-8425	41, 42	EXAC225H202X	46	MS47008	29	WK4703Q-20KSB	4		
D1311-8426	41, 42	EXAC225H301X	46	MS52070	29	WK4703Q-23KSB	4		
D1311-8426SD	41, 42	EXAC225H302X	46	MS52080	29	WK4704Q-23KSB	4		
D1312-8427	41, 42	EXAC225L201X	46	SBECPL	33	WK4705Q-23KSB	4		
D1369-8479	41, 42	EXAC225L202X	46	WK1308E-20KSB	4	WK4707Q-20KSB	5		
D1369-8479SD	41, 42	HK11HH754	37	WK1308E-23KSB	4	WK4707Q-23KSB	5		
D1370-8480	41, 42	HK1225D-150	5, 9,10	WK1308Q-20KSB	4	WK4707Q-23KSBHTP	5		
D1370-8480SD	41, 42	HK1225DX	5, 9, 10	WK1308Q-23KSB	4				
D1407-8515	41,43			WK1443E-20KSB	4				



SilverbackHD Customer Service
1-855-244-SBSB (7272) Toll Free

SilverbackHD Tech Line
1-855-848-TECH (8324) Toll Free

Cross Reference on
SilverbackHD Website

www.silverbackhd.com

SilverbackHD is a registered trademark of SilverbackHD Products, Inc. Aero Gear, Alliance, Automann, Accuride, Allison, Bendix, Bendix ADB22X™, Bosch, Clark, Conti Tech, Dana, Dayton, Dexter, Dodge, Eaton, Ford, Firestone, Fleetpride, Fleetrite, Freightliner, Fruehauf, GM, Goodyear Veyance, Goodyear Stemco, Granning, Hayes, Hendrickson, IHC, Intraax®, Isuzu, Kenworth, Kershaw, KIC, Kenworth, Mack, Meritor, MotorWheel, Navistar, Peterbilt, Pro-Par, Reyco Granning, Ridewell, Road Choice, SAF Holland, Spicer, Standard Forge, Triangle, TRP, TRW, Volvo, Wabco, Watson & Chalin, Workhorse and World America are registered trademarks of their respective companies. Any references in this catalogue to company names or trademarks are solely for identification and cross reference purposes and implies no rights of ownership by SilverbackHD Products.



SilverbackHD Products
5600 Timberlea Boulevard
Mississauga, Ontario L4W 4M6
Tel 855-244-SBSB (7272)
Tech Line 855-848-TECH (8324)
Tech.Support@silverbackhd.com
www.silverbackhd.com

SB-CAT-1221